



### ■ Features :

- Universal AC input / Full range (up to 295VAC)
- Protections: Short circuit / Over current / Over voltage / Over temperature
- Cooling by free air convection
- Built-in constant current limiting circuit with adjustable OCP level
- Fully isolated plastic case with IP64 level
- Built-in active PFC function
- Pass LPS
- Class II power unit, no FG
- Class 2 power unit
- 100% full load burn-in test
- High reliability
- Suitable for LED lighting and moving sign applications (Note.2)
- Compliance to worldwide safety regulations for lighting
- 2 years warranty



### SPECIFICATION

MODEL	PLN-30-9	PLN-30-12	PLN-30-15	PLN-30-20	PLN-30-24	PLN-30-27	PLN-30-36	PLN-30-48	
OUTPUT	DC VOLTAGE	9V	12V	15V	20V	24V	27V	36V	48V
	CONSTANT CURRENT REGION Note.6	6.3 ~ 9V	8.4 ~ 12V	10.5 ~ 15V	14 ~ 20V	16.8 ~ 24V	18.9 ~ 27V	25.2 ~ 36V	33.6 ~ 48V
	RATED CURRENT	3.3A	2.5A	2A	1.5A	1.25A	1.12A	0.84A	0.63A
	CURRENT RANGE	0 ~ 3.3A	0 ~ 2.5A	0 ~ 2A	0 ~ 1.5A	0 ~ 1.25A	0 ~ 1.12A	0 ~ 0.84A	0 ~ 0.63A
	RATED POWER	29.7W	30W	30W	30W	30W	30.24W	30.24W	30.24W
	RIPPLE & NOISE (max.) Note.2	2.6Vp-p	2Vp-p	2.6Vp-p	2.6Vp-p	2.6Vp-p	2.3Vp-p	4.5Vp-p	3.7Vp-p
	VOLTAGE ADJ. RANGE Note.5	-5% ~ 10%. Can be adjusted by internal potentiometer SVR1							
	CURRENT ADJ. RANGE Note.5	3% ~ -25%. Can be adjusted by internal potentiometer SVR2							
	VOLTAGE TOLERANCE Note.3	±10%							
	LINE REGULATION	±3.0%							
LOAD REGULATION	±5.0%								
SETUP TIME	500ms / 230VAC 3000ms / 115VAC at full load								
INPUT	VOLTAGE RANGE Note.4	90 ~ 295VAC		127 ~ 417VDC					
	FREQUENCY RANGE	47 ~ 63Hz							
	POWER FACTOR (Typ.)	PF>0.95/115VAC, PF>0.9/230VAC, PF>0.9/277VAC at full load (Please refer to "Power Factor Characteristic" curve)							
	EFFICIENCY (Typ.)	80%	82.5%	83.5%	84%	84%	84.5%	85%	85.5%
	AC CURRENT (Typ.)	0.4A/115VAC		0.2A/230VAC		0.15A/277VAC			
	INRUSH CURRENT (Typ.)	COLD START 35A(twidth=25µs measured at 50% Ipeak) at 230VAC							
LEAKAGE CURRENT	<0.5mA / 240VAC								
PROTECTION	OVER CURRENT	100 ~ 110%							
		Protection type : Constant current limiting, recovers automatically after fault condition is removed							
	SHORT CIRCUIT	Hiccup mode, recovers automatically after fault condition is removed.							
	OVER VOLTAGE	10 ~ 14V	14 ~ 17V	17 ~ 22V	23 ~ 26V	27 ~ 34V	31 ~ 35V	40 ~ 50V	53 ~ 63V
	Protection type : Shut down o/p voltage, re-power on to recover								
OVER TEMPERATURE	Shut down o/p voltage, re-power on to recover								
ENVIRONMENT	WORKING TEMP.	-30 ~ +50°C (Refer to "Derating Curve")							
	WORKING HUMIDITY	20 ~ 95% RH non-condensing							
	STORAGE TEMP., HUMIDITY	-40 ~ +80°C, 10 ~ 95% RH							
	TEMP. COEFFICIENT	±0.06%/°C (0 ~ 50°C)							
	VIBRATION	10 ~ 500Hz, 2G 12min./1cycle, period for 72min. each along X, Y, Z axes							
SAFETY & EMC	SAFETY STANDARDS	UL879, UL1310, CSA C22.2 No. 207-M89(except for 48V), TUV EN61347-1, EN61347-2-13, CAN/CSA C22.2 No.223-M91 (except for 48V),IP64, J61347-1,J61347-2-13 approved							
	WITHSTAND VOLTAGE	I/P-O/P:3.75KVAC							
	ISOLATION RESISTANCE	I/P-O/P:100M Ohms / 500VDC / 25°C/ 70% RH							
	EMC EMISSION	Compliance to EN55015, EN61000-3-2 Class C (pin≥25W), Class D (>70% load) ; EN61000-3-3							
EMC IMMUNITY	Compliance to EN61000-4-2,3,4,5,6,8,11, EN55024, EN61547, light industry level, criteria B								
OTHERS	MTBF	621.4Khrs min. MIL-HDBK-217F (25°C)							
	DIMENSION	145*47*30mm (L*W*H)							
	PACKING	0.22Kg; 60pcs/14.2Kg/1.25CUFT							
NOTE	<ol style="list-style-type: none"> <li>1. All parameters NOT specially mentioned are measured at 230VAC input, rated load and 25°C of ambient temperature.</li> <li>2. Ripple &amp; noise are measured at 20MHz of bandwidth by using a 12" twisted pair-wire terminated with a 0.1uf &amp; 47uf parallel capacitor.</li> <li>3. Tolerance : includes set up tolerance, line regulation and load regulation.</li> <li>4. Derating may be needed under low input voltage. Please check the static characteristics for more details.</li> <li>5. Output voltage can be adjusted through the SVR1 on the PCB; limit of output constant current level can be adjusted through the SVR2 on the PCB.</li> <li>6. Please refer to "DRIVING METHODS OF LED MODULE".</li> <li>7. The power supply is considered as a component that will be operated in combination with final equipment. Since EMC performance will be affected by the complete installation, the final equipment manufacturers must re-qualify EMC Directive on the complete installation again.</li> <li>8. Direct connecting to LEDs is suggested, but is not suitable for using additional drivers.</li> <li>9. To fulfill requirements of the latest ErP regulation for lighting fixtures, this LED power supply can only be used behind a switch without permanently connected to the mains.</li> </ol>								

**Mechanical Specification**

Case No.964A Unit:mm

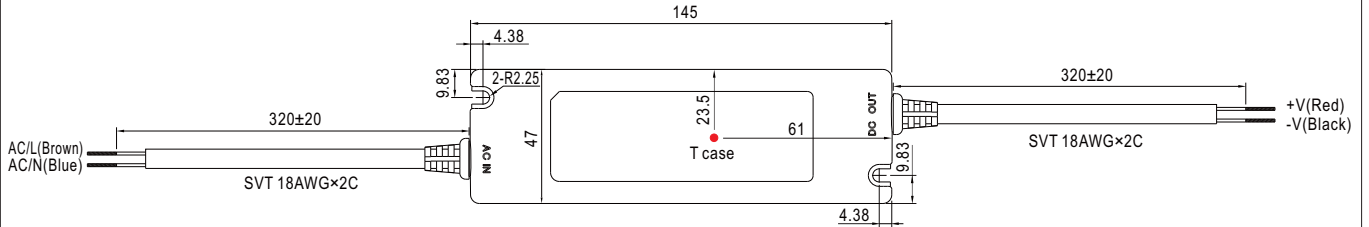

※ T case: Max. Case Temperature.

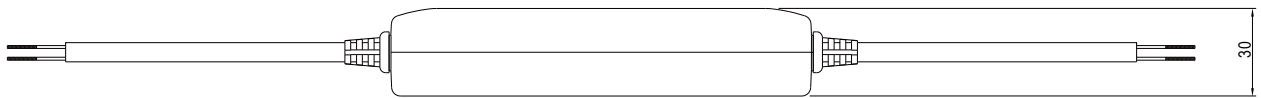

Output voltage and current adjustment : remove the upper case and adjust through SVR1 & SVR2 shown in the diagram.

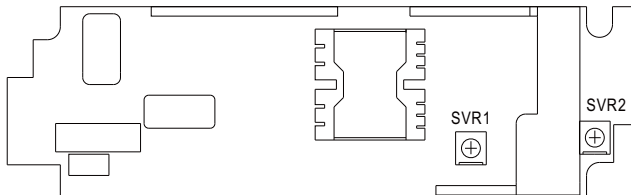

SVR1	Output voltage adjustment
SVR2	Output current adjustment

**Block Diagram**

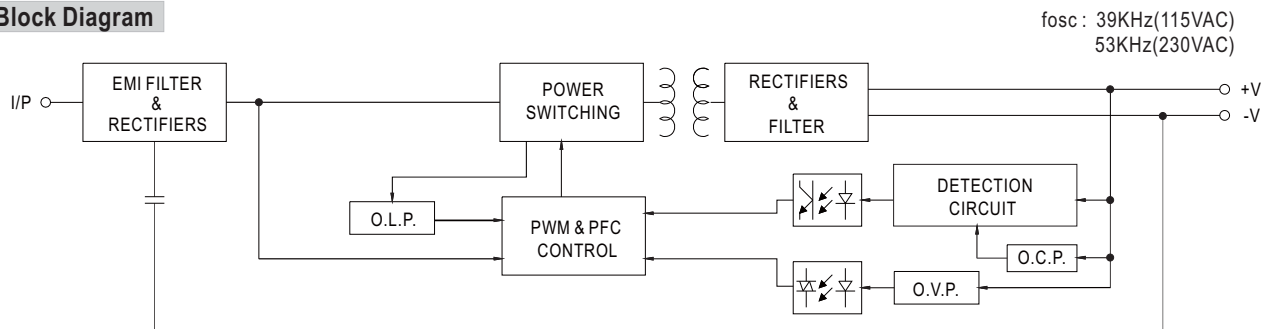

**Derating Curve**

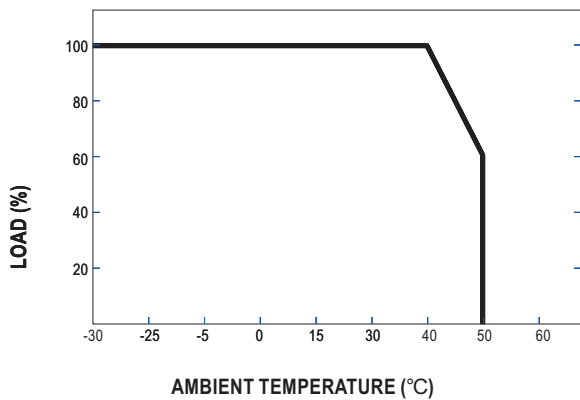

**Static Characteristics**

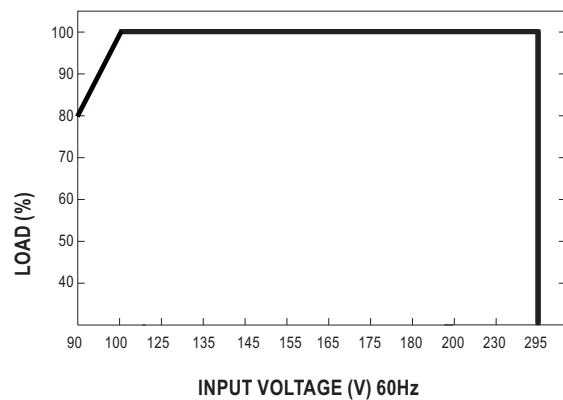

**Power Factor Characteristic**

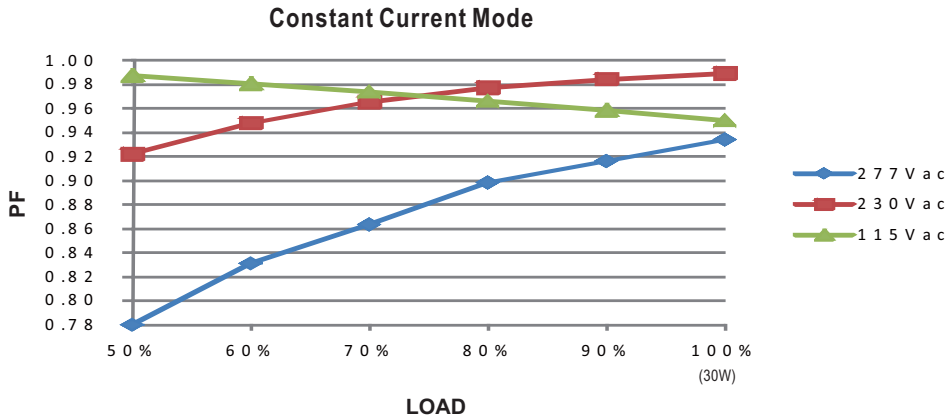

**EFFICIENCY vs LOAD (48V Model)**

PLN-30 series possess superior working efficiency that up to 85.5% can be reached in field applications.

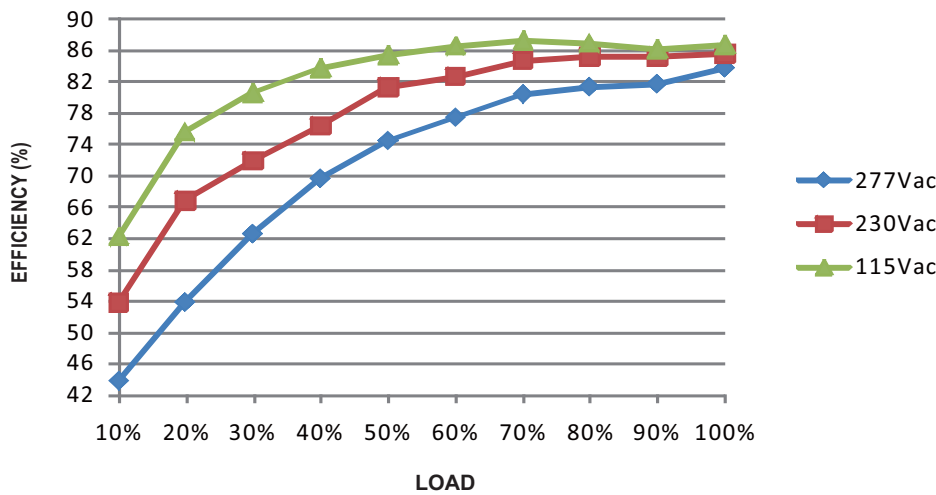

**DRIVING METHODS OF LED MODULE**

This LED power supply is suggested to work in constant current mode area (CC) to drive the LEDs.

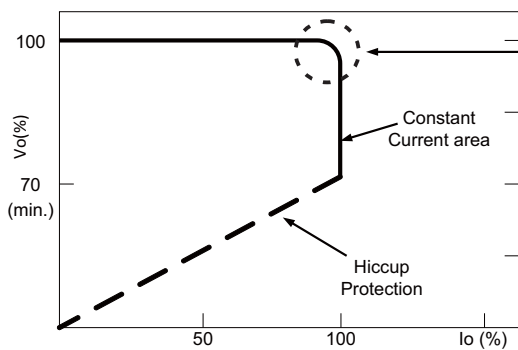

Typical LED power supply I-V curve

In the constant current region, the highest voltage at the output of the driver depends on the configuration of the end systems. Should there be any compatibility issues, please contact MEAN WELL.