

**DESCRIPTION: Wide Input Non-Isolated, Regulated Single Output**

The TP78xx-1 series has high efficiency, short circuit protection, Thermal shutdown, no heat sink required, Industry standard pinout.ideal for redialing 78xx linear regulates and are pin compatible.

**FEATURES**

ROHS Compliant	Wide input non-isolated, regulated single output	Efficiency up to 93%
Short circuit protection, Thermal shutdown	Temperature range: -40°C ~ +85°C	Low ripple noise
SIP package	No heat sink required	Industry standard pinout

**SELECTION GUIDE**

Part Number	Input Voltage (VDC)		Output		Efficiency (%)	
	Nominal	Range	Voltage (VDC)	Current (mA)	Vin (Min)	Vin(Max)
TP781.5-1	12	4.75~18	1.5	1000	78	72
TP781.8-1	12	4.75~18	1.8	1000	82	76
TP782.5-1	12	4.75~18	2.5	1000	87	82
TP783.3-1	12	4.75~20	3.3	1000	90	83
TP785.0-1	12	6.5~20	5.0	1000	93	85

**OUTPUT CHARACTERISTICS**

Parameter	Conditions	Min	Typ.	Max.	Units
Output voltage accuracy	100% full load, input voltage range		±2	±3	
Line regulation	Vin=min. to max, at full load		±0.5	±0.75	%
Load regulation	10% to 100% load		±0.5	±1.0	
Ripple & Noise	20MHz bandwidth,(refer to figure 3)		25	45	mvp-p
Short circuit protection			Continuous, auto-recovery		
Thermal shutdown	Internal IC junction		150		°C
Output current limit			3000		mA
Switching frequency	Full load, input voltage range	335	385	435	KHz
Dynamic load stability				±100	mA
Quiescent current	Vin from min to max and at 0% load		7	10	mA
Temperature coefficient	-40°C~+85°C			±0.02	%/°C
Max capacitance load				1000	µF

All specifications typical at TA=25°C, nominal input voltage and rated output current unless otherwise specified.

**COMMON SPECIFICATIONS**

Parameter	Conditions	Min.	Typ.	Max.	Units
Storage humidity range				95	
Operating temp. range	Power derating (above 71°C)	-40		85	
Storage temp. range		-55		125	°C
Storage temp. Range Temp rise at full load				100	
Lead temperature	1.5mm from case for 10 seconds			300	
Cooling		Free air convection			
Case material		Plastic (UL94-V0)			
MTBF	25°C (MIL-HDBK-217F)	2000			k hours
Weight			2.0		g

**TEMPERATURE DERATING GRAPHS      EXTERNAL CAPACITOR TABLE**

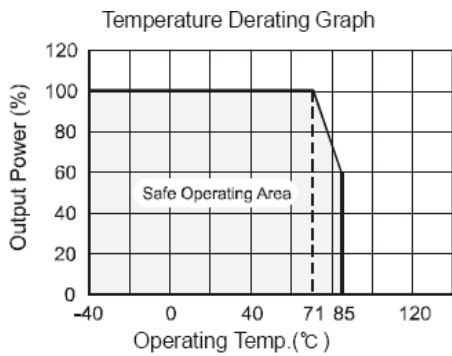

Part Number	C1(Ceramic Capacitor)	C2(Ceramic Capacitor)
TP781.5-1	10μF/25V	22μF/6.3V
TP781.8-1	10μF/25V	22μF/6.3V
TP782.5-1	10μF/25V	22μF/10V
TP783.3-1	10μF/25V	22μF/16V
TP785.0-1	10μF/25V	22μF/16V

**STANDARD APPLICATION CIRCUIT**

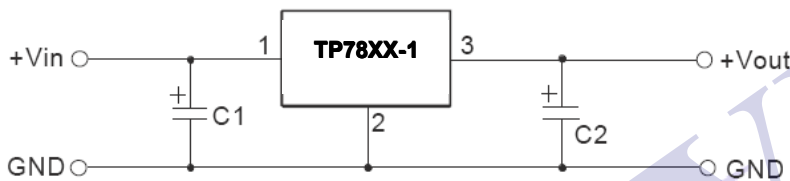

- Note:
1. C1 and C2 are required and should be fitted close to the converter pins.
  2. The capacitance of C1,C2 sees external capacitor table, it can be increased properly if required, and tantalum or low ESR electrolytic capacitors may also suffice.
  3. No parallel connection or plug and play.

**TEST CONFIGURATIONS (TA=25°C)**

1. Efficiency and Output Voltage Ripple Test

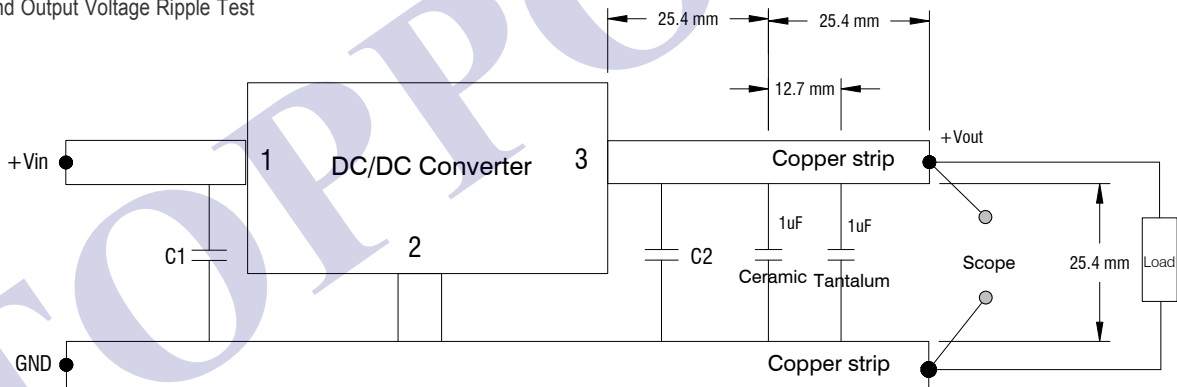

2. Start-up and Load Transient Response Test

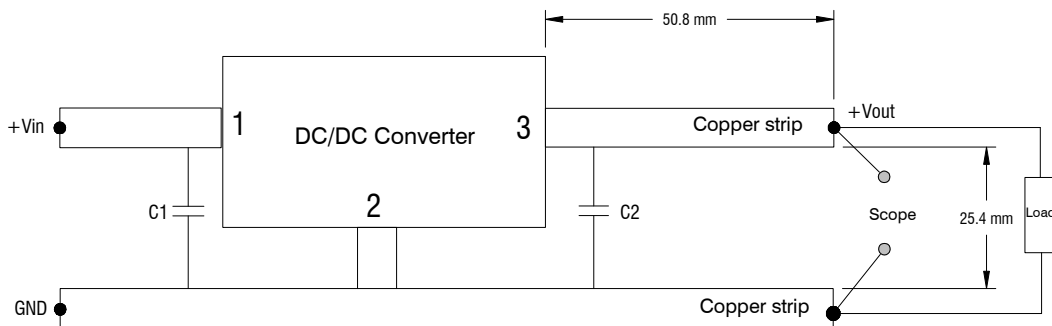

**OUTPUT RIPPLE REDUCTION**

To reduce output ripple, it is recommended to add a LC filter in output port. L: Recommended parameter  $10 \mu H \sim 47 \mu H$ .

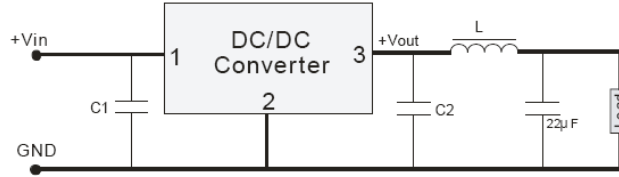

**MECHANICAL DIMENSIONS**

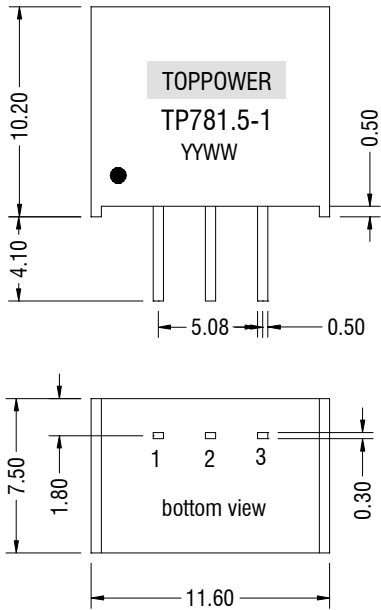

PIN CONNECTIONS	
Pin	Function
1	+Vin
2	GND
3	+Vout

All dimensions in mm  $\pm 0.25$ . All pins on a 2.54mm pitch.

**RECOMMENDED FOOTPRINT DETAILS**

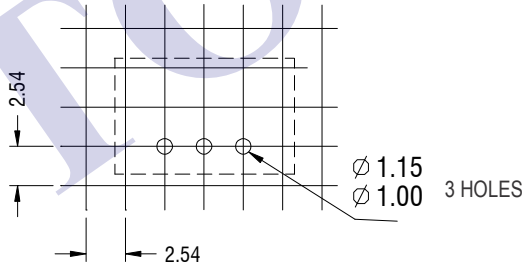

Unless otherwise stated all dimensions in mm  $\pm 0.5$ mm.

**TUBE OUTLINE DIMENSIONS**

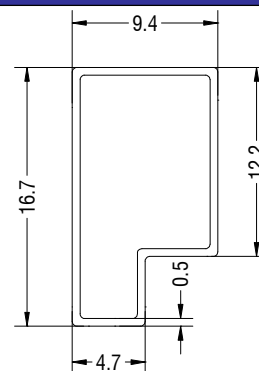

Unless otherwise stated all dimensions in mm  $\pm 0.5$ mm.

L=520mm  $\pm 2$ mm    Packaging quantity:43PCS

L=220mm  $\pm 2$ mm    Packaging quantity:17PCS