

DESCRIPTION: 5W 2.5KV Isolation Wide Input AC/DC Converters

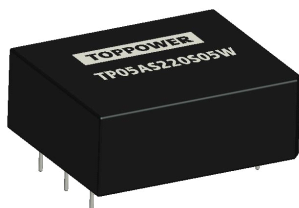

The rated output power of TP05AS converters is 5W with wide input voltage range, for both AC input and DC input application. High reliability, precision, large power density, ultra-small size, no external heat sink required, stable output voltage and etc, with over current protection, EMI filter circuit, the rectifier filter circuit, 2500V isolation voltage, short circuit, overload, internal thermal protection, Widely used in telecommunications, industrial control, instrument, data acquisition, signal control and other electronic systems.

FEATURES

Universal input voltage range	Both for AC and DC input voltage	Wide input voltage : 2:1 and 4:1
Fixed switching frequency	Overheat protection	Over current protection
Short circuit protection	RoHS compliant	Operating temperature -25°C to 70°C

SELECTION GUIDE

Part Number	Input Voltage		Output		Efficiency (Typ.) %	Recommend output external capacitor		
	Rated	Range values (VAC)	Voltage (VDC)	Current (A)		C1、C2、C3	C4	C5、C6
TP05AS220S05	220(2:1)	165-265	5	1.00	75	0.1uF/25V	470uF/16V	/
TP05AS220S12	220(2:1)	165-265	12	0.42	79	0.1uF/25V	330uF/25V	/
TP05AS220S15	220(2:1)	165-265	15	0.35	80	0.1uF/25V	330uF/25V	/
TP05AS220S24	220(2:1)	165-265	24	0.22	82	0.1uF/25V	220uF/35V	/
TP05AS220D05	220(2:1)	165-265	±5	±0.50	75	0.1uF/25V	330uF/16V	330uF/16V
TP05AS220D12	220(2:1)	165-265	±12	±0.21	79	0.1uF/25V	330uF/16V	330uF/16V
TP05AS220D15	220(2:1)	165-265	±15	±0.17	79	0.1uF/25V	220uF/25V	220uF/25V
TP05AS220D05P05	220(2:1)	165-265	+5/+5	0.8/0.2	73	0.1uF/25V	470uF/16V	330uF/16V
TP05AS220D05P12	220(2:1)	165-265	+5/+12	0.6/0.2	73	0.1uF/25V	470uF/16V	220uF/25V
TP05AS220D05P15	220(2:1)	165-265	+5/+15	0.6/0.15	73	0.1uF/25V	470uF/16V	220uF/25V
TP05AS220D05P24	220(2:1)	165-265	+5/+24	0.6/0.1	75	0.1uF/25V	470uF/16V	100uF/35V
TP05AS220T05D05	220(2:1)	165-265	+5/±5	0.8/±0.1	72	0.1uF/25V	470uF/16V	220uF/16V
TP05AS220T05D12	220(2:1)	165-265	+5/±12	0.6/±0.1	73	0.1uF/25V	470uF/16V	100uF/25V
TP05AS220T05D15	220(2:1)	165-265	+5/±15	0.6/±0.08	74	0.1uF/25V	470uF/16V	100uF/25V
TP05AS220T05D24	220(2:1)	165-265	+5/±24	0.6/±0.05	75	0.1uF/25V	470uF/16V	100uF/35V
TP05AS220S05W	220(4:1)	85-265	5	1.00	75	0.1uF/25V	470uF/16V	/
TP05AS220S12W	220(4:1)	85-265	12	0.42	79	0.1uF/25V	330uF/25V	/
TP05AS220S15W	220(4:1)	85-265	15	0.35	80	0.1uF/25V	330uF/25V	/
TP05AS220S24W	220(4:1)	85-265	24	0.22	82	0.1uF/25V	220uF/35V	/
TP05AS220D05W	220(4:1)	85-265	±5	±0.50	75	0.1uF/25V	330uF/16V	330uF/16V
TP05AS220D12W	220(4:1)	85-265	±12	±0.21	79	0.1uF/25V	330uF/16V	330uF/16V
TP05AS220D15W	220(4:1)	85-265	±15	±0.17	79	0.1uF/25V	220uF/25V	220uF/25V
TP05AS220D05P05W	220(4:1)	85-265	+5/+5	0.8/0.2	73	0.1uF/25V	470uF/16V	330uF/16V
TP05AS220D05P12W	220(4:1)	85-265	+5/+12	0.6/0.2	73	0.1uF/25V	470uF/16V	220uF/25V
TP05AS220D05P15W	220(4:1)	85-265	+5/+15	0.6/0.15	73	0.1uF/25V	470uF/16V	220uF/25V
TP05AS220D05P24W	220(4:1)	85-265	+5/+24	0.6/0.1	75	0.1uF/25V	470uF/16V	100uF/35V
TP05AS220T05D05W	220(4:1)	85-265	+5/±5	0.8/±0.1	72	0.1uF/25V	470uF/16V	220uF/16V
TP05AS220T05D12W	220(4:1)	85-265	+5/±12	0.6/±0.1	73	0.1uF/25V	470uF/16V	100uF/25V
TP05AS220T05D15W	220(4:1)	85-265	+5/±15	0.6/±0.08	74	0.1uF/25V	470uF/16V	100uF/25V
TP05AS220T05D24W	220(4:1)	85-265	+5/±24	0.6/±0.05	75	0.1uF/25V	470uF/16V	100uF/35V

All specifications typical at TA=25°C, nominal input voltage and rated output current unless otherwise specified.

GENERAL CHARACTERISTICS

Parameter	Conditions	Min.	Typ.	Max.	Units
Isolation voltage	Input / Output 1 minute, leakage current 2mA		2500		VAC
Seismic	10~55Hz	5	5		G
Over-current protection	Full input range		Burp, Automatic recovery		
Cooling	Free air convection				
Case material	Flame-retardant plastic				

INPUT CHARACTERISTICS

Parameter	Conditions	Min.	Typ.	Max.	Units
Startup voltage	220VAC In module(165V-265V)	165	220	265	VAC
Startup voltage	220VAC In module(85V-265V)	85	220	265	VAC
Start rising time	Non-capacitive load	20			ms

OUTPUT CHARACTERISTICS

Parameter	Conditions	Min.	Typ.	Max.	Units
Voltage accuracy	Io=0.1...1.0 x Ionom Vi=Vi rated			±3	%
				±5	%
Line regulation	Vimin≤Vi≤Vimax		±0.5		%
Load regulation	Io=0.1...1.0 x Ionom Vimin≤ Vi≤Vimax		±1		%
Auxiliary voltage accuracy	Main Load and auxiliary load differ 25%,the auxiliary circuit of the load with at least 25%, the main circuit with the full load			±3	%
Ripple and noise	20MHz bandwidth			±1	%
Over-current protection	Vimin≤Vi≤Vimax	120			%
Switch frequency	Vimin≤Vi≤Vimax		100K		Hz

ENVIRONMENT CHARACTERISTICS

Parameter	Conditions	Min.	Typ.	Max.	Units
Operating temperature	industrial-class	-25		+70	°C
Maximum case temperature	industrial-class			+85	°C
Storage temperature	Industry-class	-40		+85	°C
Relative humidity	No condensation	5		90	RH(%)
Temperature coefficient			±0.02		%/°C

Case temperature shall not exceed the maximum case temperature

MECHANICAL DIMENSIONS

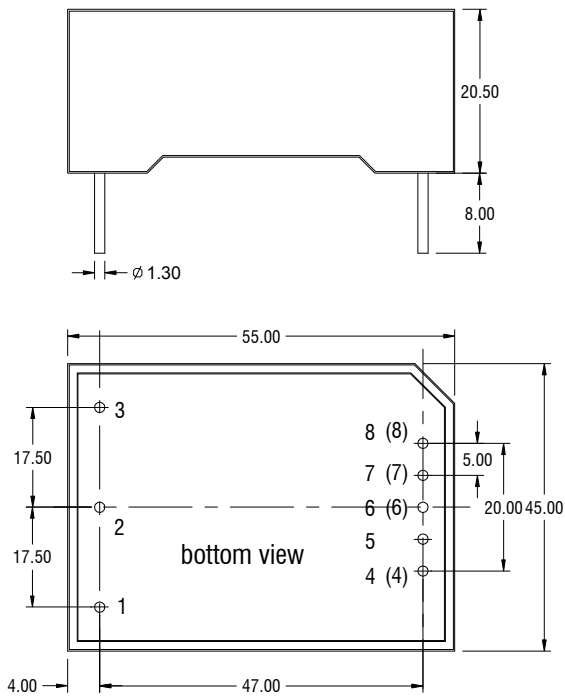

Units:mm

Tolerance:±0.2mm

PIN CONNECTION				
Pin	Single output	Dual output (Com)	Dual output (NC)	Triple output
1	FG	FG	FG	FG
2	N	N	N	N
3	L	L	L	L
4	-V0	-V0	/	/
(4)	/	/	-V01	-V01
5	/	/	+V01	+V01
6	/	COM	/	/
(6)	/	/	/	-V02
7	/	/	-V02	/
(7)	/	/	/	COM
8	+V0	+V0	/	/
(8)	/	/	+V02	+V02

MODEL SELECTION

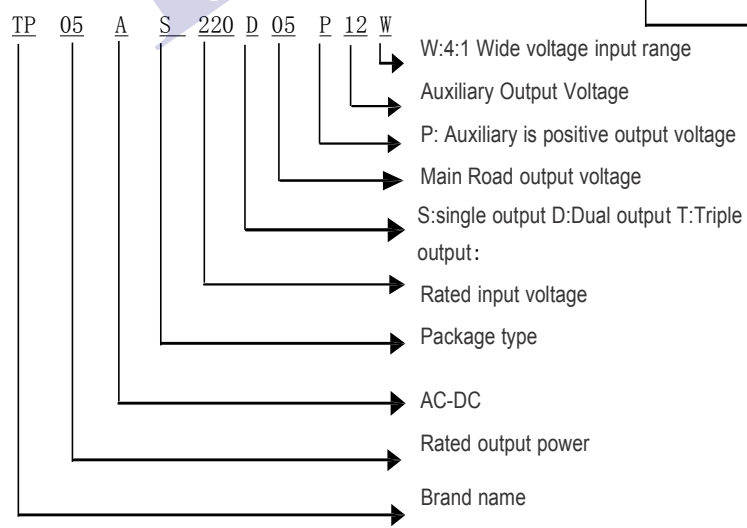
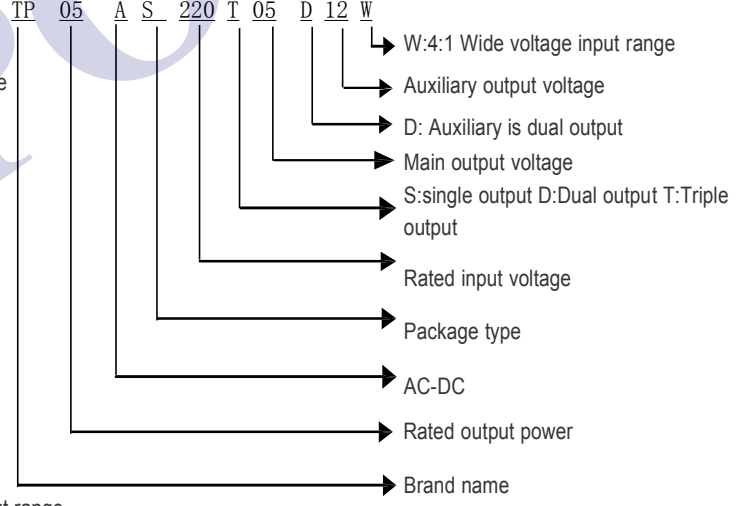
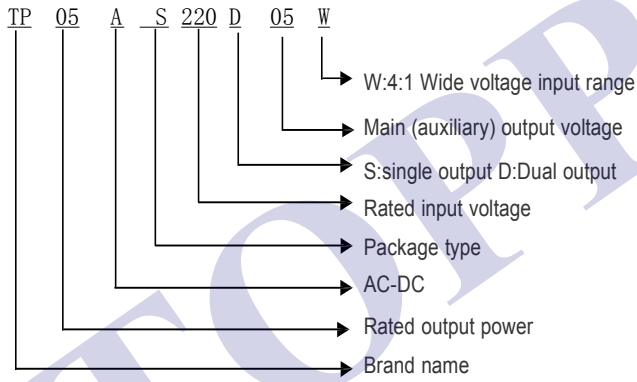

RECOMMEND CIRCUIT

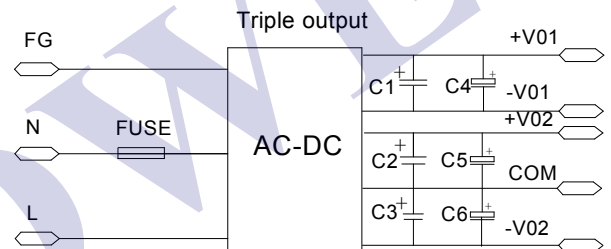
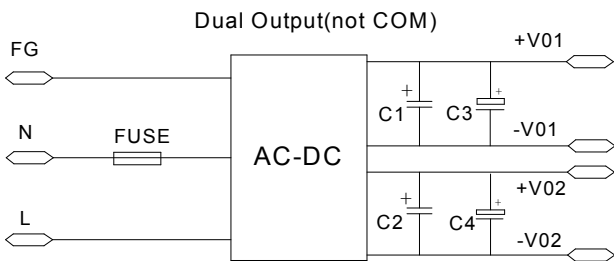
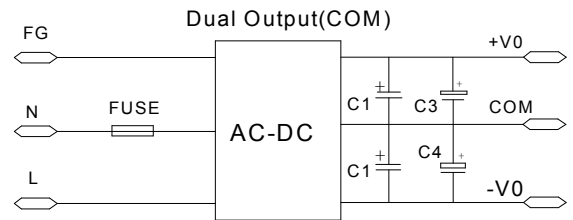
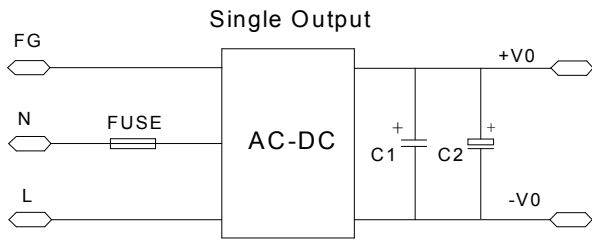

C1, C2, C3, C4, C5, C6 capacitor values refer to parameter table

USING ATTENTIONS

- Module will cause irreversible damage when it in the long-term overload state.
- Module will cause irreversible damage when it out of the state maximum input voltage range

TEMPERATURE RATING: 0°C