

DESCRIPTION: 0.5W Isolated Single Output DC/DC Converters

The TPLE-W5 series are miniature, isolated low power and high efficiency DC/DC converters in a SIP and DIP package. They offer the ideal solution in many space critical applications for board level power distribution. The internal SMD construction makes it possible to offer a product with high performance at low cost. The series offers smaller size, improved efficiency, lower output ripple noise and 1KVDC isolation. Operating temperature -40°C to 85°C

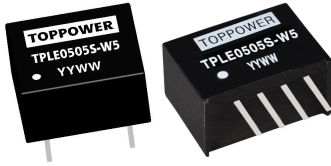

FEATURES

RoHS compliant	Single output rail	1KVDC isolation
High efficiency for low power applications	SIP & DIP package styles	Power density 0.36W/cm ³
UL 94V-0 package material	Footprint from 0.69cm ²	Input voltage: 3.3V , 5V , 12V
Output voltage: 3.3V, 5V, 9V, 12V ,15V	Custom solutions available	Operating temperature: -40°C to 85°C

SELECTION GUIDE

Part Number	Nominal Input Voltage	Output Voltage	Output Current	Efficiency	Package Style
	V	V	mA	%	
TPLE0303D-W5	3.3	3.3	152	76	DIP
TPLE0305D-W5	3.3	5	100	76	DIP
TPLE0505D-W5	5	5	100	76	DIP
TPLE0509D-W5	5	9	55.5	77	DIP
TPLE0512D-W5	5	12	41.7	78	DIP
TPLE0515D-W5	5	15	33.3	78	DIP
TPLE0303S-W5	3.3	3.3	152	76	SIP
TPLE0305S-W5	3.3	5	100	76	SIP
TPLE0505S-W5	5	5	100	76	SIP
TPLE0509S-W5	5	9	55.5	77	SIP
TPLE0512S-W5	5	12	41.7	78	SIP
TPLE0515S-W5	5	15	33.3	78	SIP
TPLE1205D-W5	12	5	100	76	DIP
TPLE1209D-W5	12	9	55.5	77	DIP
TPLE1212D-W5	12	12	41.7	78	DIP
TPLE1215D-W5	12	15	33.3	78	DIP
TPLE1205S-W5	12	5	100	76	SIP
TPLE1209S-W5	12	9	55.5	77	SIP
TPLE1212S-W5	12	12	41.7	78	SIP
TPLE1215S-W5	12	15	33.3	78	SIP

INPUT CHARACTERISTICS

Parameter	Conditions	Min.	Typ.	Max.	Units
Voltage range	3.3V input types	2.9	3.3	3.6	V
Voltage range	5V input types	4.5	5.0	5.5	V
Voltage range	12V input types	11	12	13.3	V

ISOLATION CHARACTERISTICS

Parameter	Conditions	Min.	Typ.	Max.	Units
Isolation test voltage	Tested for 1 second	1000			VDC
Resistance	Viso=1000VDC	1			GΩ

ABSOLUTE MAXIMUM RATINGS

Short-circuit protection	1 second
Lead temperature 1.5mm from case for 10 seconds	300°C
Input voltage Vin, TPLE03XXX-W5	5.5V
Input voltage Vin, TPLE05XXX-W5	7V
Input voltage Vin, TPLE12XXX-W5	15V

OUTPUT CHARACTERISTICS

Parameter	Conditions	Min.	Typ.	Max.	Units
Rated Power	TA= -40°C to 85°C			0.5	W
Voltage Set Point Accuracy	See tolerance envelope				
Line regulation	High VIN to low VIN			1.2	%/%
Load Regulation(10% load to rated load)	5V output types			16	
Load Regulation(10% load to rated load)	all other types			11	

All specifications typical at TA=25°C, nominal input voltage and rated output current unless otherwise specified.

GENERAL CHARACTERISTICS

Parameter	Conditions	Min.	Typ.	Max.	Units
Switching frequency	All input types		110		kHz

TEMPERATURE CHARACTERISTICS

Parameter	Conditions	Min.	Typ.	Max.	Units
Specification	All output types	-40		85	°C
Storage		-55		130	°C
Cooling	Free air convection				

TEMPERATURE DERATING GRAPHS

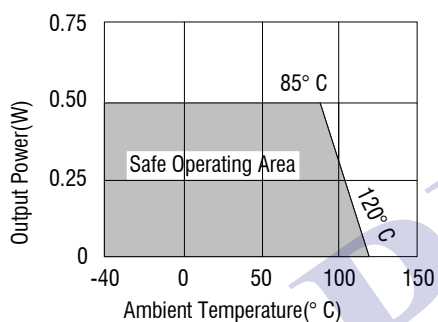

TOLERANCE ENVELOPES

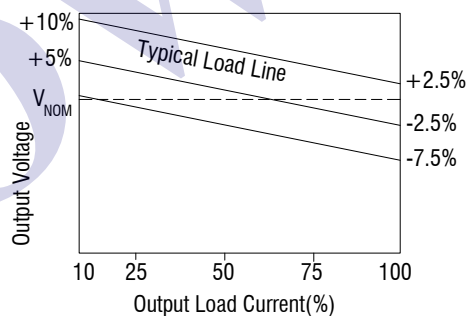

MECHANICAL DIMENSIONS

DIP Package

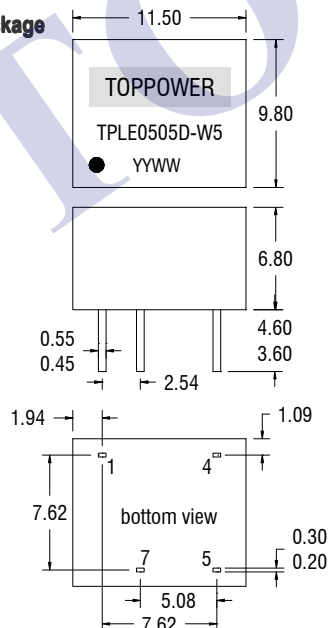

SIP Package

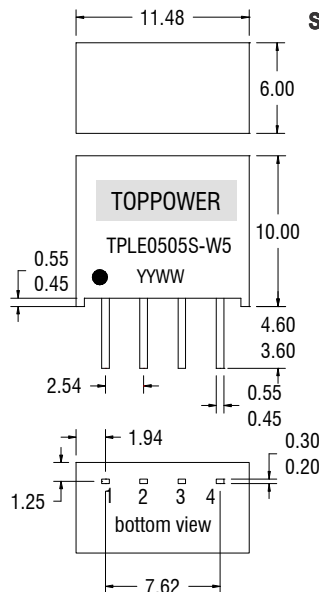

PIN CONNECTIONS-8PIN DIP	
Pin	Function
1	-Vin
4	+Vin
5	+Vout
7	-Vout

PIN CONNECTIONS-4PIN SIP	
Pin	Function
1	-Vin
2	+Vin
3	-Vout
4	+Vout

All dimensions in mm±0.25mm. All pins on a 2.54mm pitch and within±0.25mm of true position.

RECOMMENDED FOOTPRINT DETAILS

8Pin DIP Package

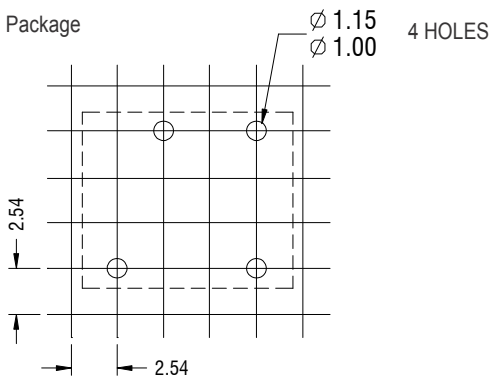

4Pin SIP Package

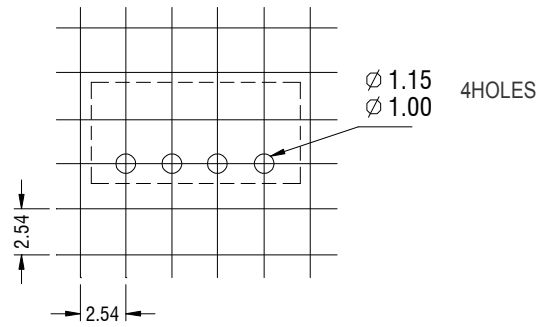

TUBE OUTLINE DIMENSIONS

8Pin DIPTube

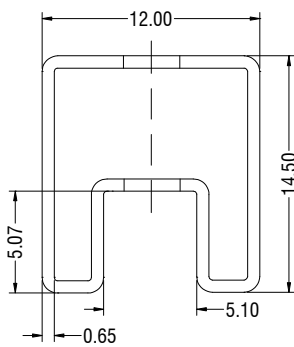

4Pin SIPTube

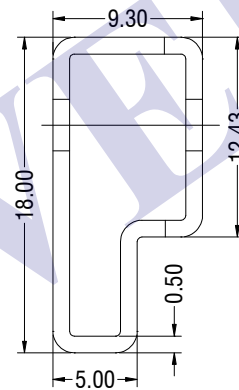

Unless otherwise stated all dimensions in mm±0.5mm.

Tube length (8 Pin DIP) : 520mm ±2mm.

Tube length (4 Pin SIP) : 520mm ±2mm.

Tube Quantity : 35

