

**ATTENTION**  
OBSERVE PRECAUTIONS  
FOR HANDLING  
ELECTROSTATIC  
DISCHARGE  
SENSITIVE  
DEVICES

HL-503S22OC-4B-2.8

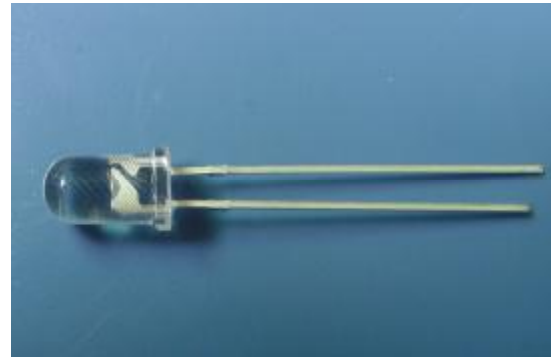

**Features**

- $\phi 5$  LAMP LED
- LOW POWER CONSUMPTION.
- CABINED VIEWING ANGLE.
- IDEAL FOR BACKLIGHT AND INDICATOR.
- PACKAGE: 1000PCS / BAG.

**Package Dimensions**

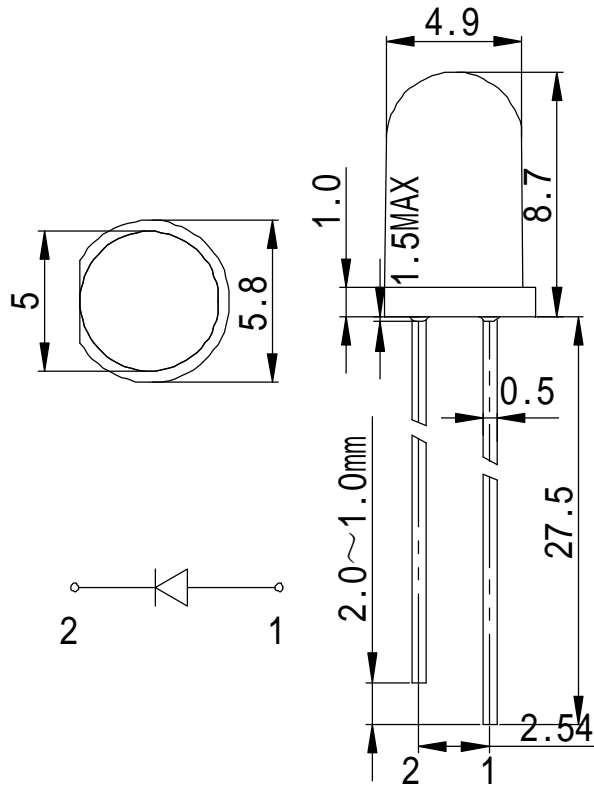

**Description**

This devices are made with TS AlGaInP

Tolerance Grade	Dimension Tolerance (UNIT:mm)			
	0.5~3	3~6	6~30	30~120
	$\pm 0.1$	$\pm 0.2$	$\pm 0.3$	$\pm 0.5$
Chip		Lens Color		
Material	Emitting Color	Water clear		
AlGaInP	Orange			

**■ Absolute Maximum Rating**

Item	Symbol	Value	Unit
Forward Current	I <sub>F</sub>	20	mA
Peak Forward Current*	I <sub>FP</sub>	100	mA
Reverse Voltage	V <sub>R</sub>	5	V
Power Dissipation	P <sub>D</sub>	80	mW
Electrostatic discharge	E <sub>SD</sub>	2000	V
Operation Temperature	T <sub>opr</sub>	-30~+80	°C
Storage Temperature	T <sub>stg</sub>	-30~+80	°C
Lead Soldering Temperature*	T <sub>sol</sub>	Max. 260°C for 5sec Max.	

\*I<sub>FP</sub> Conditions: Pulse Width ≤ 10msec

\*T<sub>sol</sub> Conditions: 3mm from the base of the epoxy bulb

**■ Typical Optical/ Electrical Characteristics Ta=25°C**

Item	Symbol	Condition	Rank	Min.	Typ.	Max.	Unit
Luminous Intensity	I <sub>v</sub>	I <sub>F</sub> =20mA	R	780		1015	mcd
			S	1015		1320	mcd
			T	1320		1715	mcd
Forward Voltage	V <sub>F</sub>			1.8	2.2	2.6	V
Viewing Angle	2θ 1/2			--	25	--	deg
Dominant Wavelength	λ <sub>D</sub>			600	--	610	nm
Recommend Forward Current	I <sub>F</sub> (rec)	--		--	--	20	mA
Reverse Current	I <sub>R</sub>	V <sub>r</sub> =5V		--	--	20	uA

Notes:

Tolerance : V<sub>F</sub> ± 0.1V, λ<sub>D</sub> ± 2 nm, I<sub>V</sub>(φ V) ± 15%, 2θ 1/2 ± 15%

**■ Reliability Performance  
 Test Items And Result**

Test Classification	Test Item	Test Conditions	Test Duration	Sample Size	AC/RE
Life Test	Room Temperature DC Operating Life Test	$T_a=25^{\circ}\text{C}\pm 5^{\circ}\text{C}$ , $I_f=20\text{mA}$	1000hrs	22 pcs	0/1
Environment Test	Thermal Shock Test	$100^{\circ}\text{C}\pm 5^{\circ}\text{C}$ 5min ↑ ↓ $-40^{\circ}\text{C}\pm 5^{\circ}\text{C}$ 5min.	100 cycles	22 pcs	0/1
	Temperature Cycle Test	$100^{\circ}\text{C}\pm 5^{\circ}\text{C}$ 30min ↑ ↓ 5min $-40^{\circ}\text{C}\pm 5^{\circ}\text{C}$ 30min.	100 cycles	22 pcs	0/1
	High Temperature & High Humidity Test	$85^{\circ}\text{C}\pm 5^{\circ}\text{C}/85\% \text{RH}$ $I_f=5\text{mA}$	1000hrs	22 pcs	0/1
	High Temperature Storage	$T_a=100^{\circ}\text{C}\pm 5^{\circ}\text{C}$	1000hrs	22 pcs	0/1
	Low Temperature Storage	$T_a=-40^{\circ}\text{C}\pm 5^{\circ}\text{C}$	1000hrs	22 pcs	0/1
Mechanical Test	Resistance to Soldering Heat	Temp= $260^{\circ}\text{C}$ max T=5sec max	1times	22 pcs	0/1
	Lead Integrity	Load 2.5N(0.25kgf) $0^{\circ} \sim 90^{\circ} \sim 0^{\circ}$	3times	22 pcs	0/1

Forward Current vs. Ambient Temperature

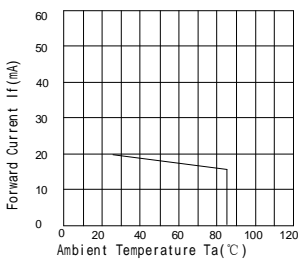

Relative Intensity vs. Ambient Temperature

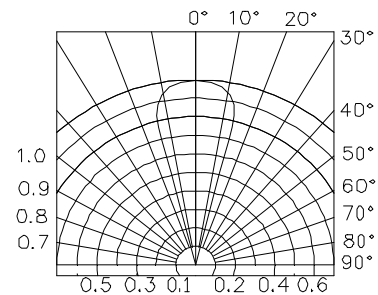
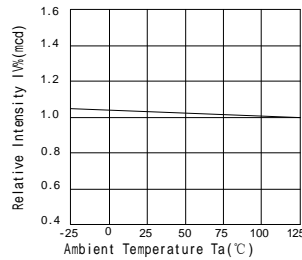

Forward Current vs. Forward Voltage

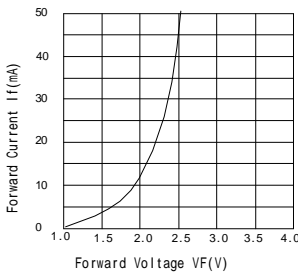

Forward Voltage vs. Ambient Temperature

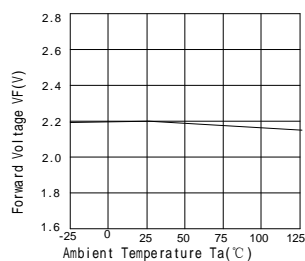
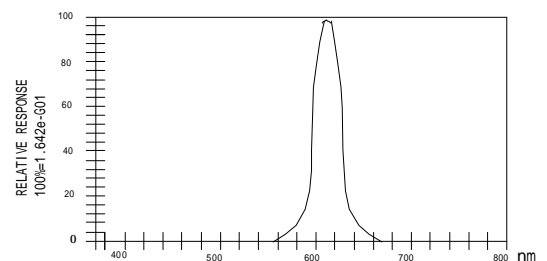
 Luminous Spectrum ( $T_a=25^{\circ}\text{C}$ ) SPECTRAL RADIANCE

**Soldering:**

## 1. Manual Of Soldering

The temperature of the iron tip should not be higher than 300°C and Soldering within 3 seconds per solder-land is to be observed.

## 2. DIP soldering (Wave Soldering):

Preheating: 120°C~150°C, within 120~180 sec.

Operation heating: 245°C±5°C within 5 sec. 260°C (Max)

Gradual Cooling (Avoid quenching).

