

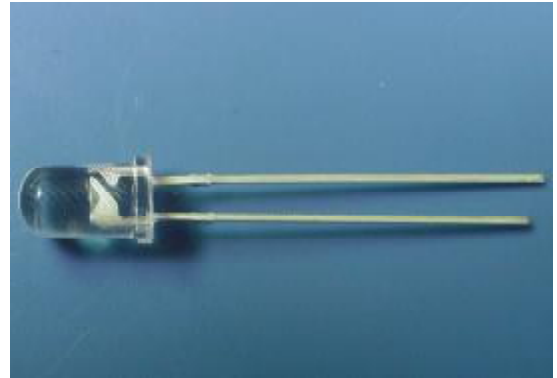

HL-503IR1C-L4

**Features**

- Mechanically and spectrally matchend to the phototransistor.
- Rohs compliant.



**Package Dimensions**

**Description**

This devices are made with PIN GaAs.

- 1: ANODE  
2: CATHODE

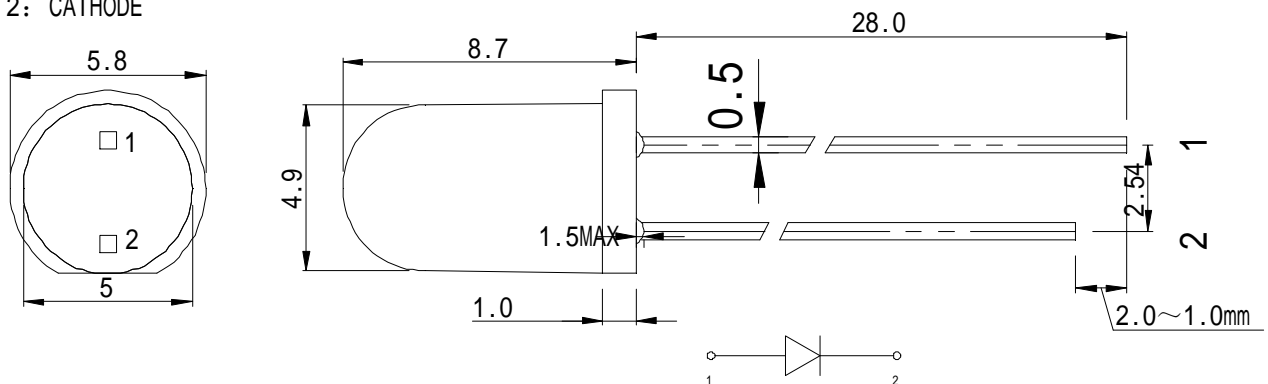

Tolerance Grade	Dimension Tolerance (UNIT:mm)			
	0.5~3	3~6	6~30	30~120
	±0.1	±0.2	±0.3	±0.5
Chip		Lens Color		
Material	Emitting Color	Water Clear		
GaAs	/			

**Selection Guide**

Part No	Radiant Intensity(mW/sr) $I_F=50mA$		Viewing Angle
	Min	Typ	2 $\theta$ 1/2 (供参考)
HL-503IR1C-L4	--	45	20

Note:

1. 2 $\theta$ 1/2 is the angle from optical centerline where the luminous intensity is 1/2 the optical centerline value.
2. Tolerance of measurement of luminous intensity $\pm$ 15%.

**Electrical / Optical Characteristics at TA=25°C**

Item	Symbol	Min	Typ	Units	Test Conditions
Forward Voltage	$V_F$		1.5	V	$I_F=50mA$
Reverse Current	$I_R$	--	10	$\mu A$	
Peak Spectral Wavelength	$\lambda_D$	--	940	nm	
Spectral Bandwidth	$\Delta \lambda_{1/2}$	--	50	nm	

Note:

1. Tolerance of measurement of forward voltage $\pm$ 0.1V.
2. Tolerance of measurement of peak Wavelength $\pm$ 2.0nm.

**Absolute Maximum ratings at Ta=25°C**

Parameter	Symbol	IR1	Units
Power Dissipation	$P_t$	100	mW
DC Forward Current	$I_F$	50	mA
Peak Forward Current[1]	$I_{FS}$	300	mA
Operation Temperature		-30 $\sim$ +80°C	
Storage Temperature		-30 $\sim$ +80°C	

Note:

1. IFP Conditions: Pulse Width $\leq$ 10msec
2. Tsol Conditions: 3mm from the base of the epoxy bulb

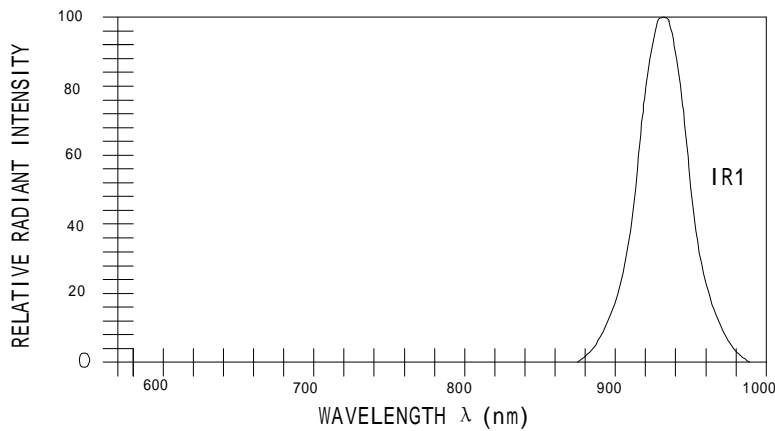

Forward Current vs. Forward Voltage

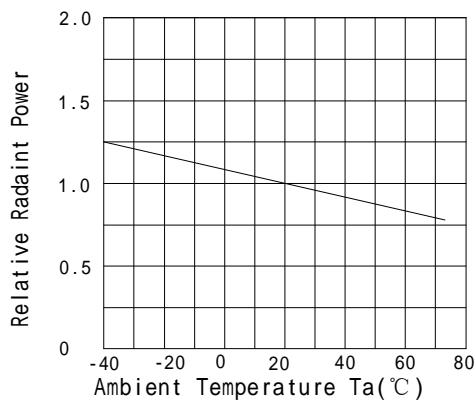

Radint Power Vs. Ambient Temperature

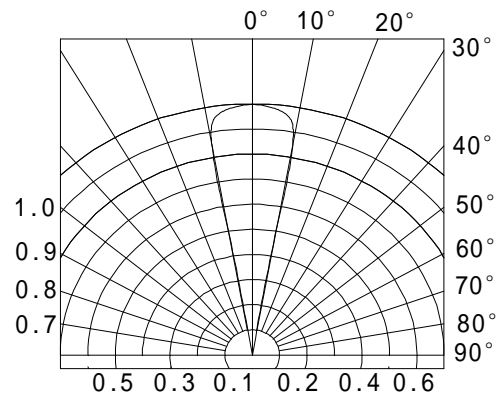

Spatial Distribution

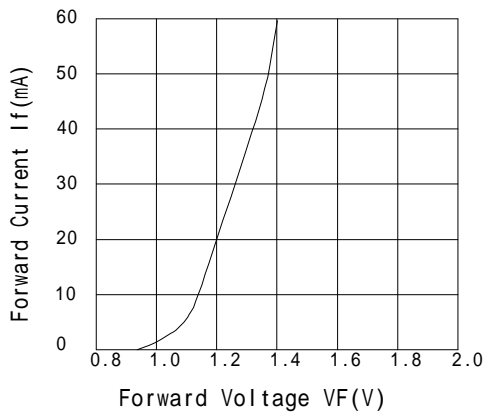

Forward Current Vs. Forward Voltage

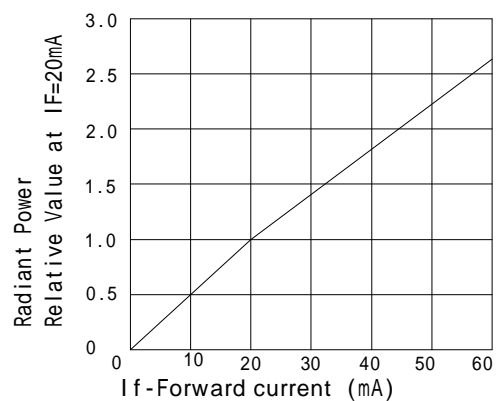

Radint Power Vs Forward Current

Remarks:

If special sorting is required (e.g. binning based on forward voltage or radiant intensity/luminous flux), the typical accuracy of the sorting process is as follows:

1. Radiant intensity/Luminous Flux:  $\pm 15\%$ .
2. Forward Voltage:  $\pm 0.1V$ .

Note: Accuracy may depend on the sorting parameters.

**Soldering:**

## 1. Manual Of Soldering

The temperature of the iron tip should not be higher than 300°C and Soldering within 3 seconds per solder-land is to be observed.

## 2. DIP soldering (Wave Soldering):

Preheating: 120°C~150°C, within 120~180 sec.

Operation heating: 245°C ± 5°C within 5 sec. 260°C (Max)

Gradual Cooling (Avoid quenching).

