



RoHS

Specification

规格书

Customer Name : _____

客户名称 :

Customer P/N : _____

客户品号 :

Factory P/N : HL-PSC-2012IR1C-L4

公司品号 :

Sending Date : _____

送样日期 :

Client approval 客户审核			Hongli approval 鸿利光电审核		
Approval 核准	Audit 确认	Confirmation 制作	Approval 核准	Audit 确认	Confirmation 制作
			殷小平		谭娅
<input type="checkbox"/> Qualified 接受		<input type="checkbox"/> Disqualified 不接受		DATE: 日期:	

Adr : Airport High-tech Industry Base Jinggu South Road(XianKe 1st Road Intersection),
Huadu District, Guangzhou, China

地址: 中国广州市花都区机场高科技产业基地金谷南路与先科一路交汇

Tel/电话 : 020-86733333

Fax/传真 : 020-86733883 86733938 86733265

Web/网址 : www.honglitronic.com

注: 1. 此规格书以中英文方式书写, 若有冲突以中文版本为准文本.

2. 此规格书的最终解释权归广州鸿利光电股份有限公司

3. 此规格书的有效期限为两年, 自盖章或签字之日起计算, 期满时双方可以续签协议, 但应采用书面形式

HL-PSC-2012IR1C-L4

Features(特征)

- Extremely wide viewing angle. (宽的发光角度)
- Suitable for all SMT assembly and solder process. (适用于所有的SMT组装和焊接工艺)
- Available on tape and reel. (适用于载带及卷轴)
- Moisture sensitivity level: Level 4. (防潮等级 Level 4)
- RoHS compliant. (RoHS 认证)

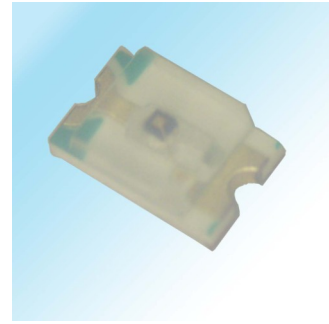

Description (描述)

IR1C-L4 made with GaAs infrared chips

IR1C-L4 由GaAs元素组成的芯片



ATTENTION
OBSERVE PRECAUTIONS
FOR HANDLING
ELECTROSTATIC
DISCHARGE
SENSITIVE
DEVICES

注意：操作时应注意静电敏感
释放设备装置

Package Dimensions (封装尺寸)

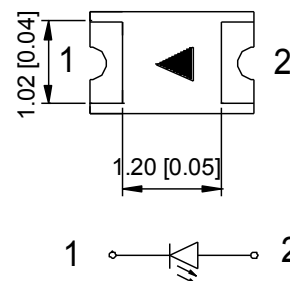
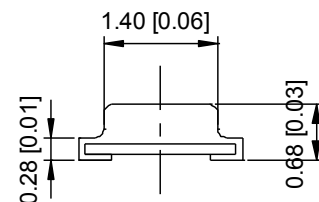
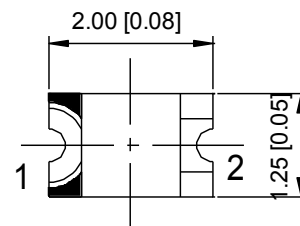

Recommended Soldering Pattern

(建议焊盘尺寸图)

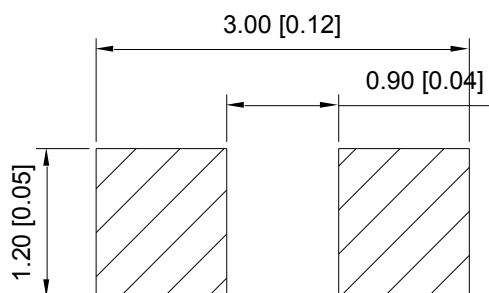

Notes: (备注)

1. All dimension units are millimeters. (所有标注尺寸单位为毫米)

2. All dimension tolerance is $\pm 0.15\text{mm}$ unless otherwise noted. (除特别标注外, 所有尺寸允许公差 $\pm 0.15\text{mm}$)



HL-PSC-2012IR1C-L4

Electrical / Optical Characteristics at Ta=25°C 电性与光学特性

Parameter (参数)	Symbol (符号)	Min. (最小)	Typ. (平均)	Max. (最大)	Units (单位)	Test Conditions 测试条件
Forward Voltage 正向电压	V _F	0.8	1.2	--	V	I _F =20mA
Reverse Current 反向电流	I _R	--	--	10	uA	V _R = 5V
Peak Wavelength 峰值波长	λ _p	--	940	--	nm	I _F =20mA
Spectrum width of Half value 半波光谱宽值	Δλ	--	50	--	nm	I _F =20mA
Viewing Angle 可视角度	1/2θ	--	120	--	deg	I _F =20mA

Absolute Maximum Ratings at Ta=25°C 绝对最大额定值

Parameter (参数)	Symbol (符号)	Infrared (值)	Units (单位)
Power Dissipation (功耗)	P _T	75	mW
DC Forward Current (正向电流)	I _F	30	mA
Peak Forward Current [1] (峰值正向电流)	i _{FS}	1.2	A
Reverse Voltage反向电压	V _R	5	V
Operating/Storage Temperature (操作温度)	T _A	-40 ~ 85	°C
Storage Temperature (保存温度)	T _{STG}	-40 ~ 100	°C

Note: (备注)

1. 1/10 Duty cycle, 0.1ms pulse width. (脉宽0.1ms, 周期1/10)
2. The above forward voltage measurement allowance tolerance is ±0.1V. (以上所示电压测量误差±0.1V)

HL-PSC-2012IR1C-L4

Typical optical characteristics curves 典型光学特性曲线

Ambient Temperature VS. Relative Intensity
环境温度与相对光强特性曲线

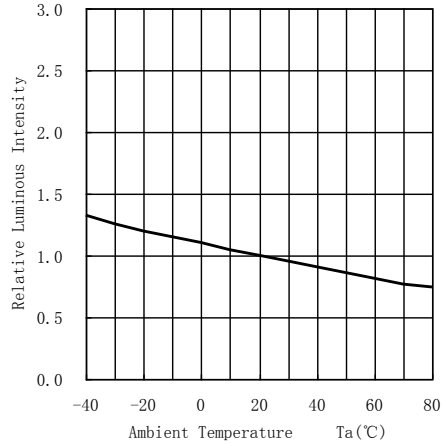

Radiation diagram
辐射图特性曲线

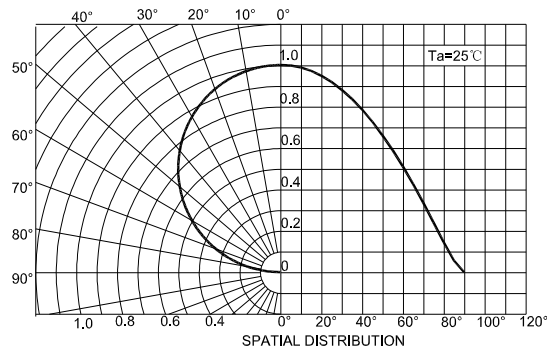

Relative spectral emission
相对光谱分布特性曲线

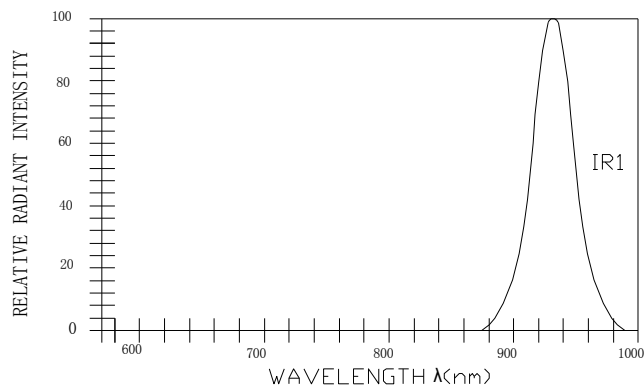



HL-PSC-2012IR1C-L4

SMT Reflow Soldering Instructions SMT回流焊说明

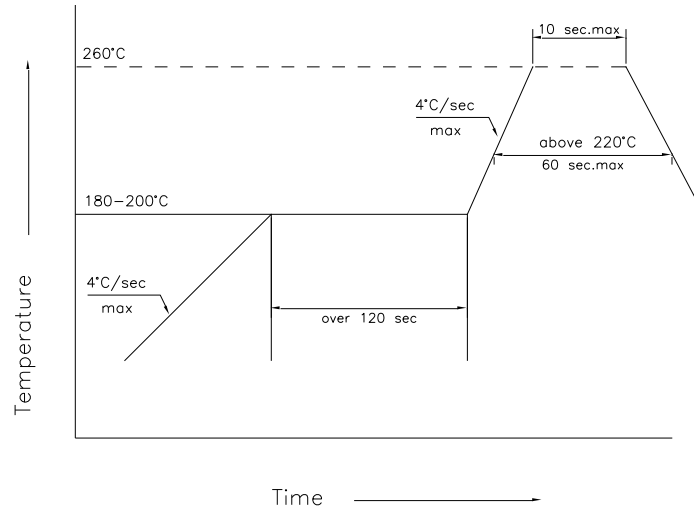

- 1.Reflow soldering should not be done more than two times. 回流焊不可以做两次以上
- 2.When soldering , do not put stress on the LEDs during heating
当焊接时，不要在材料受热时用力压胶体表面

Soldering iron 烙铁焊接

- 1.When hand soldering, keep the temperature of iron below less 300°C less than 3 seconds
当手工焊接时，烙铁的温度必须小于300°C，时间不可超过3秒
- 2.The hand solder should be done only one times
手工焊接只可焊接一次

Repairing 修补

Repair should not be done after the LEDs have been soldered. When repairing is unavoidable, a double-head soldering iron should be used (as below figure). It should be confirmed in advance whether the characteristics of LEDs will or will not be damaged by repairing.

LED回流焊后不应该修复，当修复是不可避免时，必须使用双头烙铁（如下图），但必须事先确认此种方式会或不会损坏LED本身的特性。

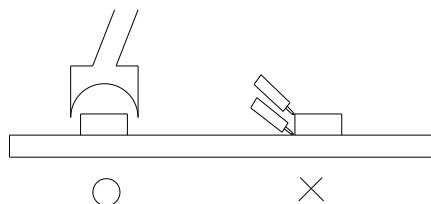

HL-PSC-2012IR1C-L4

Label 标签

IV: Luminous intensity rank 亮度等级
 WD: Dominate Wavelength 波长等级
 VF: Forward voltage rank 电压等级



HONGLITRONIC
鸿利光电

RoHS

Part No: XXXXXXXXXXXXXXXXXXXXXXXX
 IV: VF: WD:
 Quantity:
 Sealing date: XXXXXXXXXXXXXXXXXXXX



Tape Specifications (Units : mm) 载带规格 (单位: mm)

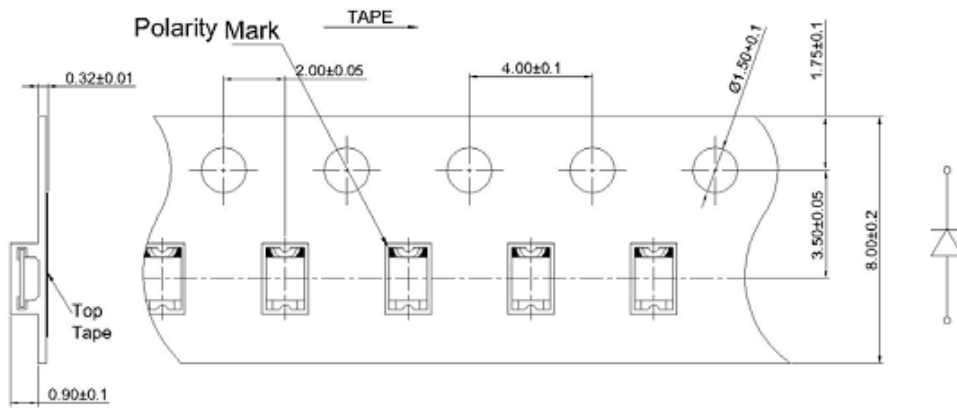

Reel Dimensions 卷轴尺寸

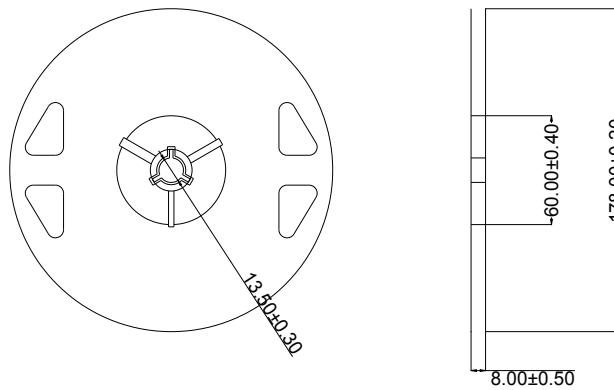

Moisture Resistant Packaging 防潮带包装

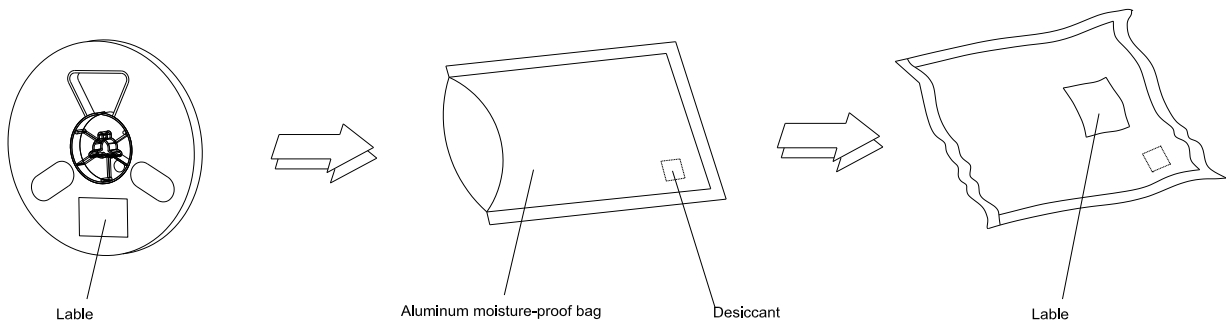

Note: The tolerances unless mentioned is $\pm 0.1\text{mm}$, Unit: mm 注: 标注公差为 $\pm 0.1\text{mm}$, 单位: mm