

**High Power Emitter LED**  
**P/N: HL-C3535F4G1EA-ZW(Green)**

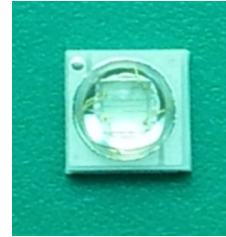

**ATTENTION**  
OBSERVE PRECAUTIONS  
FOR HANDLING  
ELECTROSTATIC  
DISCHARGE  
SENSITIVE  
DEVICES



**Features**

- Dimension 3.45mm×3.45mm×1.9mm
- Long operating life
- High efficiency
- Lambertian radiation pattern
- Low voltage DC operated
- Cool beam, safe to the touch
- High heat dissipation efficiency
- Superior ESD protection
- RoHS compliant

**Applications**

Small size, Flexible design



...

**Package Dimensions**

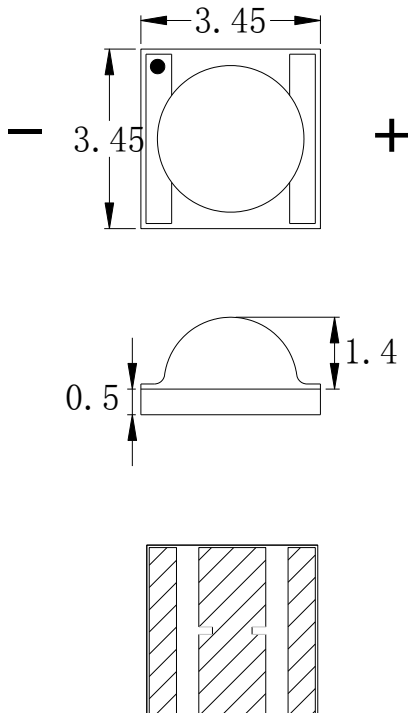

**Recommended Soldering**

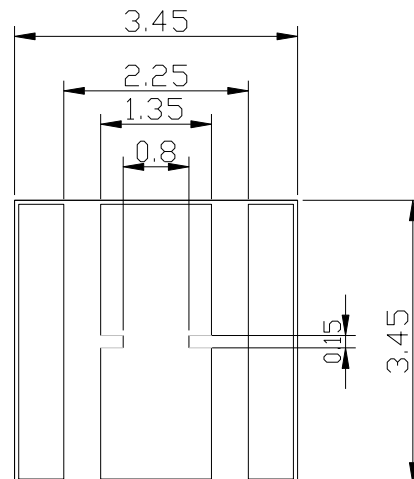

**Notes:**

1. All dimension units are millimeters.
2. All dimension tolerance is  $\pm 0.2\text{mm}$  unless otherwise noted.

## High Power Emitter LED

### P/N: HL-C3535F4G1EA-ZW(Green)

### Radiation Pattern

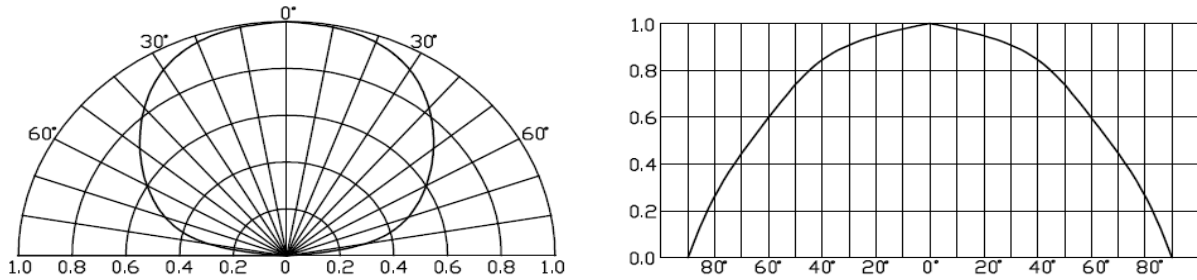

### Device Selection Guide

Part No.	Chip		Lens Color
	Material	Emitting Color	
HL-C3535FXXG1EA	—	Green	Water clear

### Electrical / Optical Characteristics at TA=25°C

Symbol	Parameter	Device	Min.	Typ.	Max.	Units	Test Conditions
$\Phi_V$	Luminous Flux	Green	—	98	—	lm	IF=350mA
VF	Forward Voltage [1]		3.0	—	3.6	V	IF=350mA
$\lambda_d$	Wave Length		530	—	535	nm	IF=350mA
$2\theta_{1/2}$	50% power angle		120	—	140	deg	IF=350mA
IR	Reverse Current		—	—	30	$\mu$ A	VR = 5V

Note:

- 1.For each die.
2. $\theta_{1/2}$  is the angle from optical centerline where the luminous flux is 1/2 the optical center-line value.
- 3.The value only for reference.

### Absolute Maximum Ratings at TA=25°C

Parameter	Symbol	Rating	Units
Power dissipation[1]	Pd	1	W
DC Forward Current[1]	IF	350	mA
Reverse Voltage[1]	VR	5	V
Operating Temperature Range	Topr	-20°C To +65°C	
Storage Temperature Range	Tstg	0C To +40°C	

Note:

- 1.1/10 Duty Cycle,0.1ms Pulse Width.
- 2.The temperature of Aluminum PCB do not exceed 55°C.



Under Development	
Mass production	●

# High Power Emitter LED

## P/N: HL-C3535F4G1EA-ZW(Green)

### Typical Optical/Electrical Characteristics Curves ( $T_a=25^{\circ}\text{C}$ Unless Otherwise Noted )

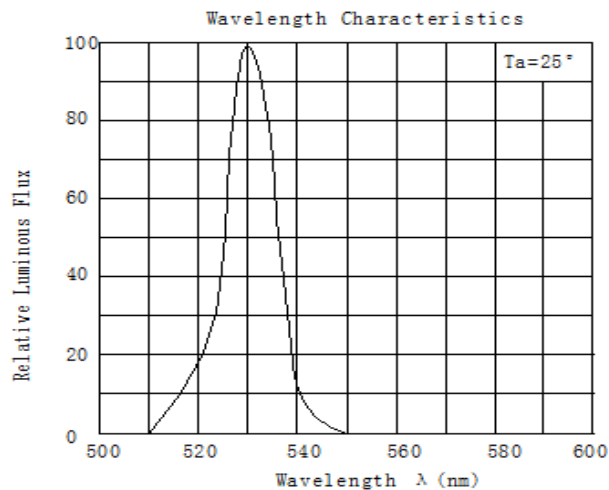
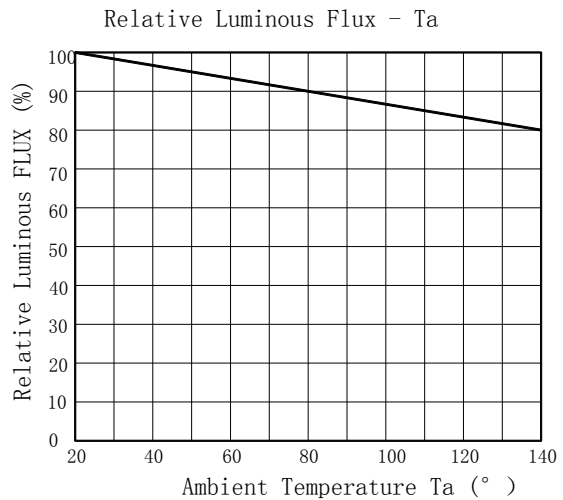
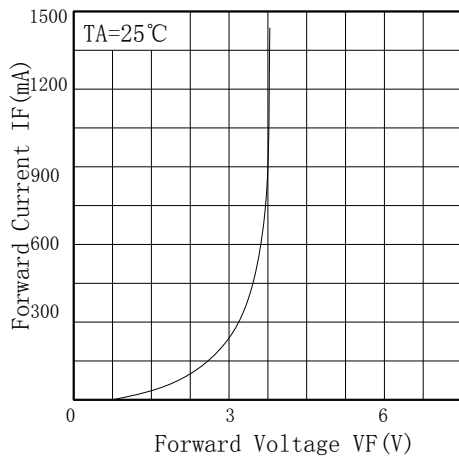
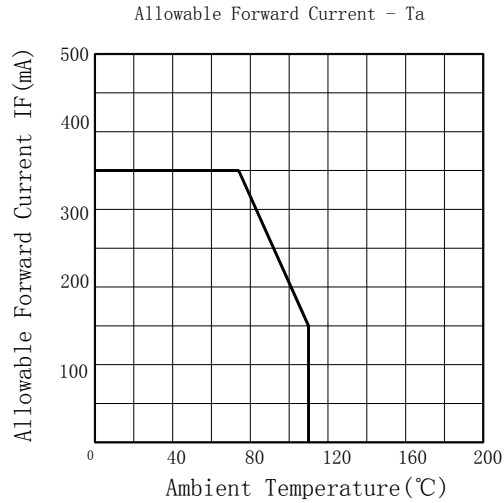
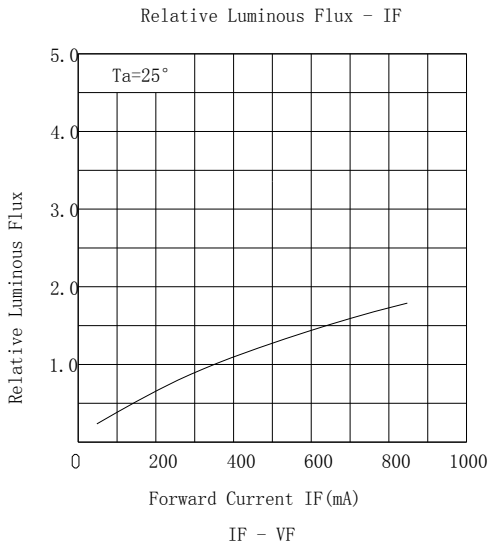

## High Power Emitter LED

### P/N: HL-C3535F4G1EA-ZW(Green)

### Soldering

#### Manual Of Soldering

The temperature of the iron tip should not be higher than 260°C (500°F) and Soldering within 3 seconds per solder-land is to be observed.

**Reflow soldering** : (All temperatures refer to topside of package, measured on the package body surface.)

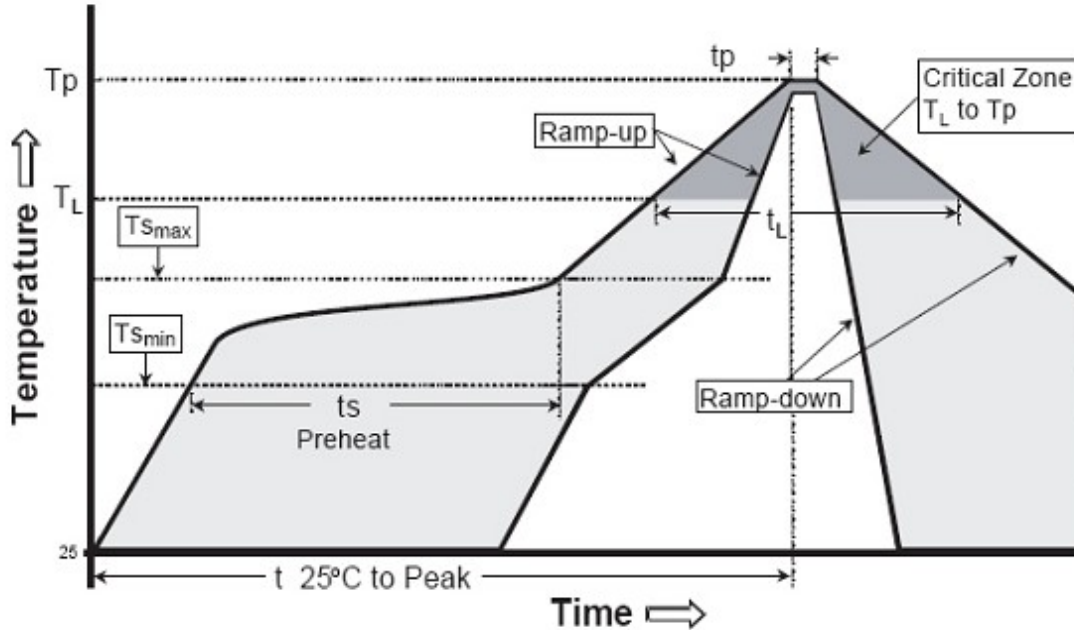

Profile Feature	Lead-Based solder	Lead-Free Solder
Average Ramp-Rate (Tsmax to Tp)	3°C/second max	3°C/second max
Preheat: Temperature Min (Tsmin)	100°C	150°C
Preheat: Temperature Max (Tsmax)	150°C	200°C
Preheat: Time (tsmin to tsmax)	60-120 seconds	60-180 seconds
Time Maintained Above: Temperature (Tl)	183°C	217°C
Time Maintained Above: Time (tL)	60-150 seconds	60-150 seconds
Peak/Classification Temperature (Tp)	215°C	260°C
Time Within 5°C of Actual Peak Temperature (tp)	10-15 seconds	20-40 seconds
Ramp-Down Rate	6°C/second max	6°C/second max
Time 25°C to Peak Temperature	6 minutes max	8 minutes max

### Caution:

1. Reflow soldering should not be done more than two times. The reflow temperature we recommend is 245°C (±5°C), the maximum soldering temperature should be limited to 260°C.

2. Repairing should not be done after the LEDs have been soldered. When repairing is unavoidable, suitable tools have to be used.

3. When soldering, do not press on the LEDs during heating.

4. After soldering, do not warp the circuit board. Do not stack PCBs containing HL-3535 LEDs so that anything rests on the LED lens.



Under Development	
Mass production	●

### High Power Emitter LED P/N: HL-C3535F4G1EA-ZW(Green)

#### Label

ΦV: Luminous Flux rank  
 VF: Forward voltage rank  
 TC: Color temperature  
 LOT.NO: Lot Number

 <b>HONGLITRONIC</b> 鸿利光电		<b>RoHS</b>
TYPE:XXXXXXXXXXXX		QTY:XXX PCS
Bin:		
ΦV: _____	TC: _____	VF: _____
DATE: _____		LOT. NO: _____

#### Tape Specifications(Units:mm)

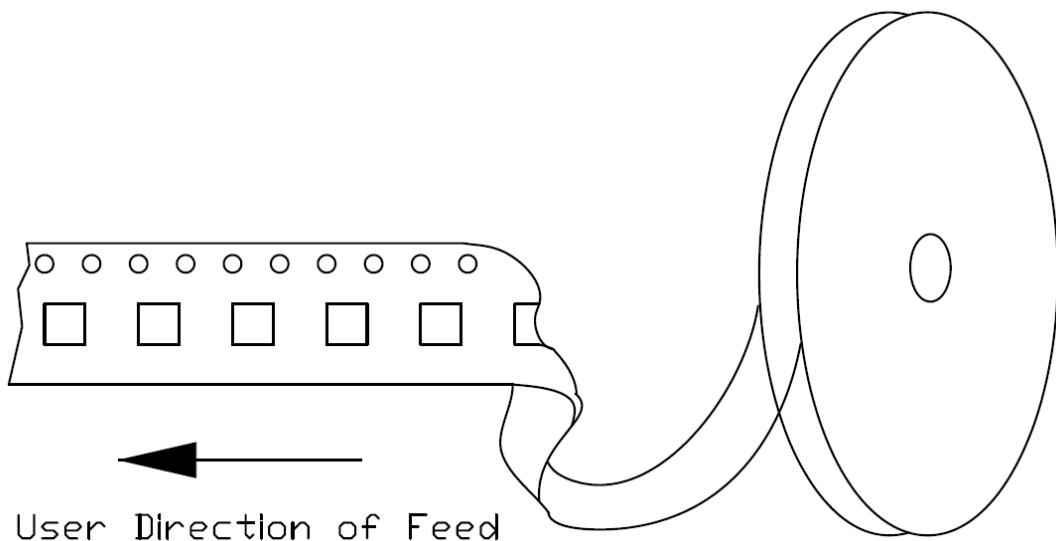
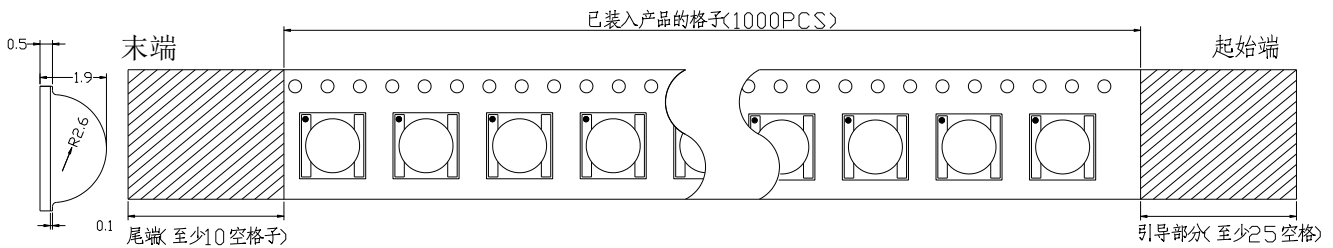



Under Development	
Mass production	●

**High Power Emitter LED**  
**P/N: HL-C3535F4G1EA-ZW(Green)**

**Packing**

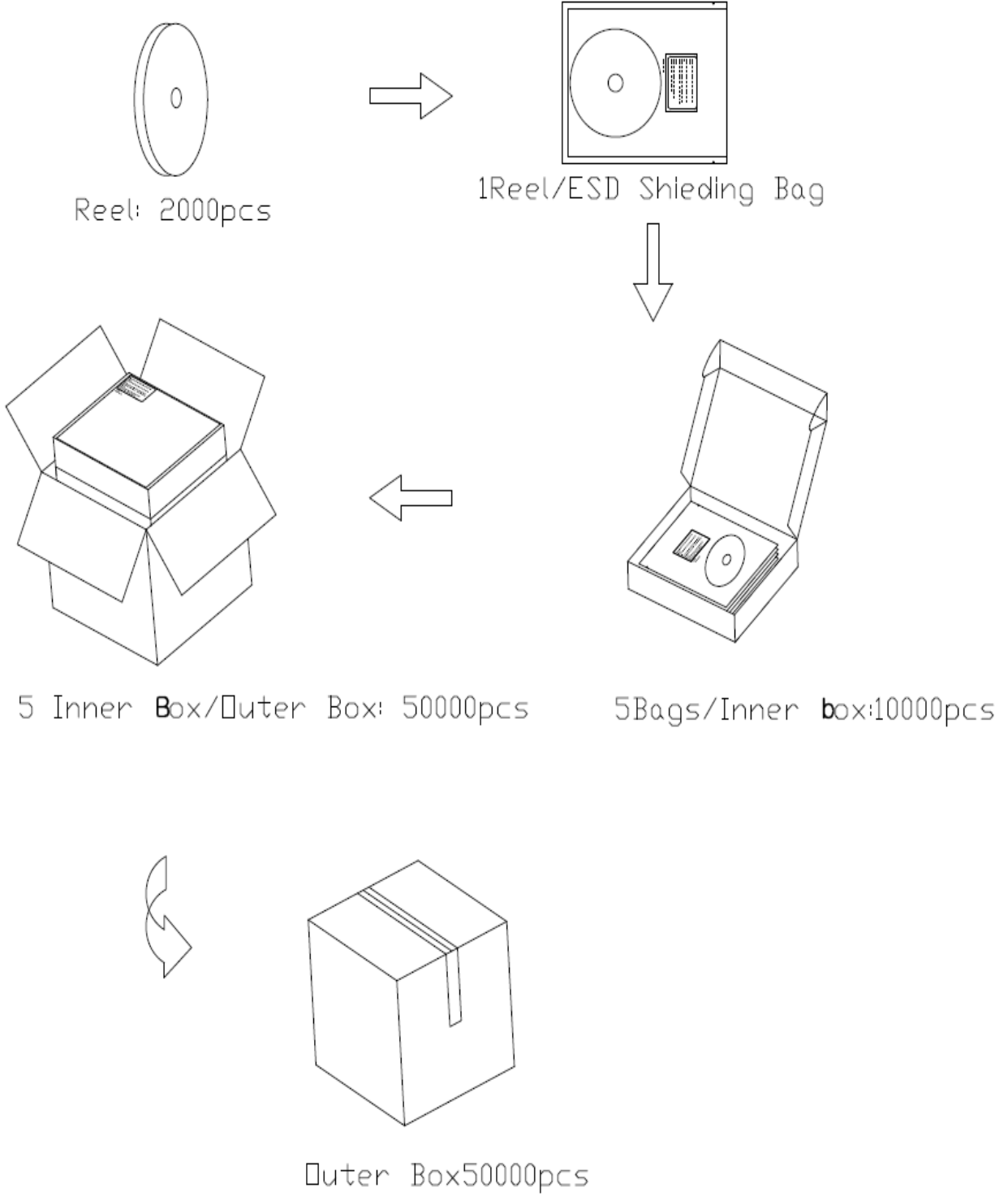

**High Power Emitter LED**  
**P/N: HL-C3535F4G1EA-ZW(Green)**

**Precaution for use**

1.Storage

To avoid the moisture penetration ,we recommend storing LEDs in a dry box (or a desiccator) with a desiccant. The recommended conditions are temperature 5 to 30 degrees Centigrade. Humidity 60% maximum.

2.Precaution after opening packing

2.1.Soldering should be done right after opening the package (within 24Hrs).

2.2.Keeping of a fraction.

-Sealing

-Temperature: 5~30°C Humidity: less than 30%

2.3.If the package has been opened than 1 week or the color of desiccant changed, components should be dried for 10-12 Hrs at 60±5°C.

3.Any mechanical force or any excess vibration shall not be accepted to apply during cooling process to normal temperature after soldering.

4.Please avoid rapid cooling after soldering.

5.Components should not be mounted on warped direction of PCB.

6.This device should not be used in any fluid such as water, oil ,organic solvent etc.

When washing is required, Isopropyl Alcohol should be used.

7.When the LEDs are illuminating, operating current should be decided after considering the package maximum temperature.

8.Avoid touching Lens parts especially by sharp tools such as pincette.

9.Please do not force over 1000g impact or pressure diagonally on the silicone lens. It will cause fatal damage on this product.

10.Please do not cover the silicone resin of the LEDs with other resin.

11.Do not use metal suction nozzle, rubber or silica gel suction nozzle is recommended.

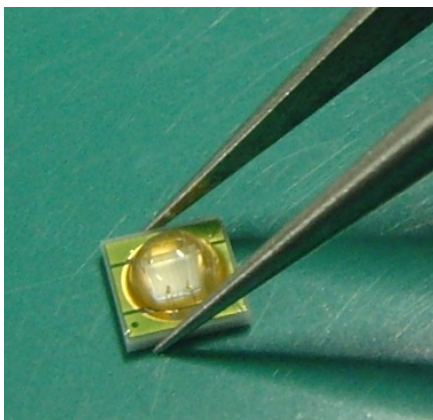

**OK**

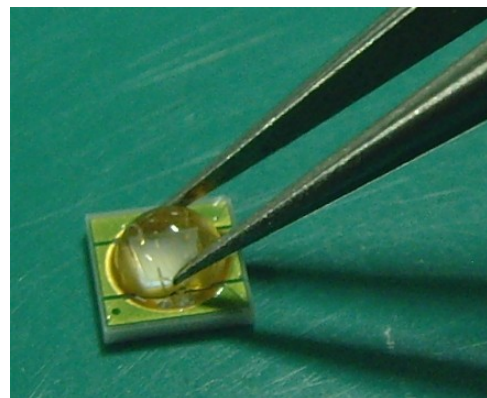

**NG**



Under Development	
Mass production	●

**High Power Emitter LED**  
**P/N: HL-C3535F4G1EA-ZW(Green)**

13. Do not stack PCBs or assemblies containing the LEDs so that anything rests on the LED lens. Force applied to the LED lens may result in the lens being knocked off. PCBs or assemblies containing the LEDs should be stacked in a way to allow at least 2 cm clearance above the LED lens.

14. Do not use bubble wrap directly on top of the LEDs. Force from the bubble wrap can potentially damage the LED.

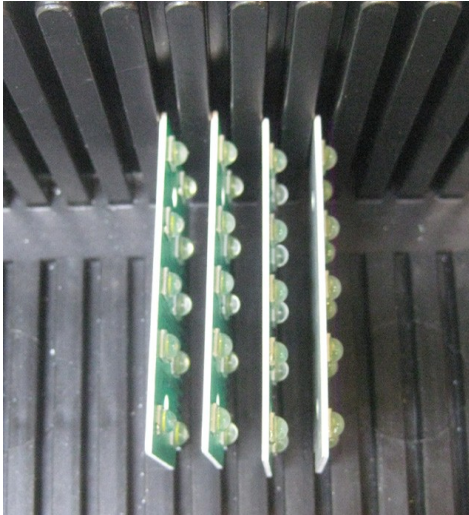

**OK**



**OK**

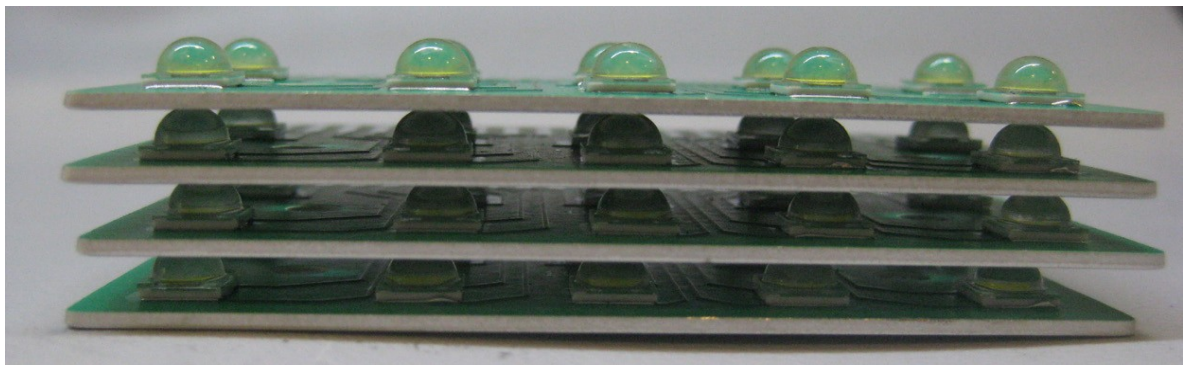

**NG**