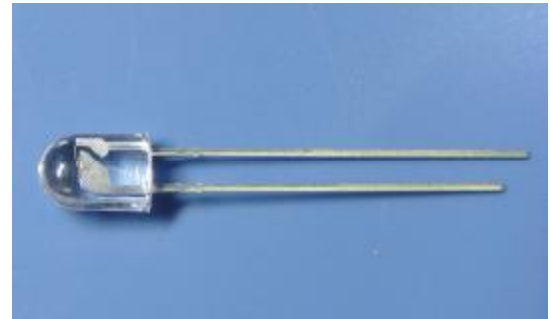
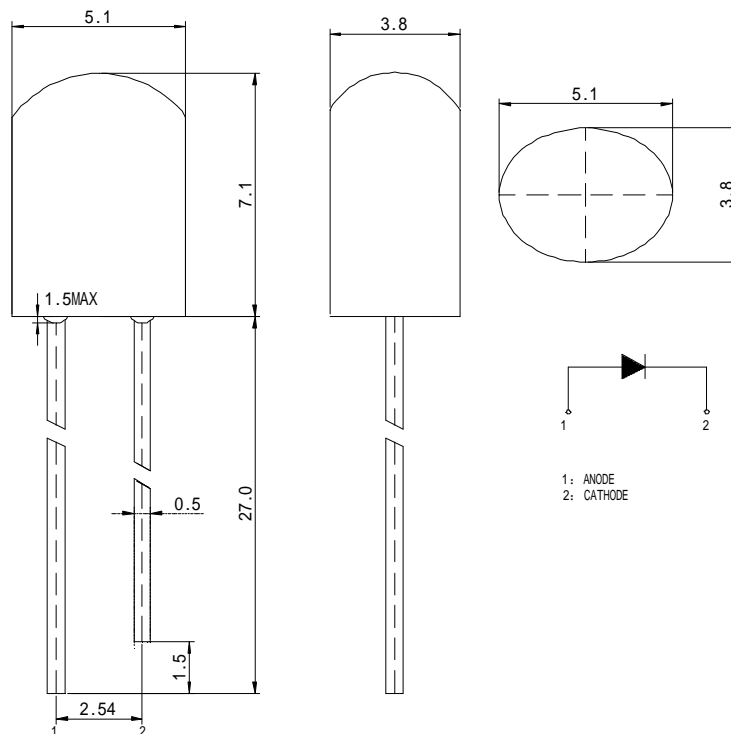

ATTENTION
 OBSERVE PRECAUTIONS
 FOR HANDLING
 ELECTROSTATIC
 DISCHARGE
 SENSITIVE
 DEVICES

HL-633U32YC

Features

- $\phi 5$ OVAL TUPE LAMP LED
- LOW POWER CONSUMPTION.
- WIDE VIEWING ANGLE.
- IDEAL FOR BACKLIGHT AND INDICATOR.
- PACKAGE: 1000PCS / BAG.

Package Dimensions

Description

This devices are made with TS AlGaInP.

Tolerance Grade	Dimension Tolerance (UNIT:mm)			
	0.5~3	3~6	6~30	30~120
	± 0.1	± 0.2	± 0.3	± 0.5
Chip		Lens Color		
Material	Emitting Color	Water Clear		
AlGaInP.	Yellow			

■ Absolute Maximum Rating

Item	Symbol	Value	Unit
Forward Current	I _F	20	mA
Peak Forward Current*	I _{FP}	100	mA
Reverse Voltage	V _R	5	V
Power Dissipation	P _D	80	mW
Electrostatic discharge	E _{SD}	2000	V
Operation Temperature	T _{opr}	-30~+80	°C
Storage Temperature	T _{stg}	-30~+80	°C
Lead Soldering Temperature*	T _{sol}	Max. 260°C for 5sec Max.	

*I_{FP} Conditions: Pulse Width ≤ 10msec

*T_{sol} Conditions: 3mm from the base of the epoxy bulb

■ Typical Optical/ Electrical Characteristics Ta=25°C

Item	Symbol	Condition	Rank	Min.	Typ.	Max.	Unit	
Luminous Intensity	I _v	I _F =20mA	T	1320		1715	mcd	
			U	1715		2230	mcd	
			V	2230		2900	mcd	
Forward Voltage	V _F			1.8	2.2	2.6	V	
Viewing Angle	2θ 1/2				--	100/X 35/Y	--	deg
Dominant Wavelength	λ _D				585	--	595	nm
Recommend Forward Current	I _F (rec)	--		--	--	20	mA	
Reverse Current	I _R	V _r =5V		--	--	20	uA	

Notes:

Tolerance : V_F ± 0.1V, λ_D ± 2 nm, I_V(φ V) ± 15%, 2θ 1/2 ± 15%

■ Reliability Performance
Test Items And Result

Test Classification	Test Item	Test Conditions	Test Duration	Sample Size	AC/RE
Life Test	Room Temperature DC Operating Life Test	$T_a=25^{\circ}\text{C}\pm 5^{\circ}\text{C}$, $I_F=20\text{mA}$	1000hrs	22 pcs	0/1
Environment Test	Thermal Shock Test	$100^{\circ}\text{C}\pm 5^{\circ}\text{C}$ 5min ↑ ↓ $-40^{\circ}\text{C}\pm 5^{\circ}\text{C}$ 5min.	100 cycles	22 pcs	0/1
	Temperature Cycle Test	$100^{\circ}\text{C}\pm 5^{\circ}\text{C}$ 30min ↑ ↓ 5min $-40^{\circ}\text{C}\pm 5^{\circ}\text{C}$ 30min.	100 cycles	22 pcs	0/1
	High Temperature & High Humidity Test	$85^{\circ}\text{C}\pm 5^{\circ}\text{C}/85\% \text{RH}$ $I_F=5\text{mA}$	1000hrs	22 pcs	0/1
	High Temperature Storage	$T_a=100^{\circ}\text{C}\pm 5^{\circ}\text{C}$	1000hrs	22 pcs	0/1
	Low Temperature Storage	$T_a=-40^{\circ}\text{C}\pm 5^{\circ}\text{C}$	1000hrs	22 pcs	0/1
Mechanical Test	Resistance to Soldering Heat	Temp= 260°C max T=5sec max	1times	22 pcs	0/1
	Lead Integrity	Load 2.5N(0.25kgf) $0^{\circ} \sim 90^{\circ} \sim 0^{\circ}$	3times	22 pcs	0/1

Forward Current vs. Ambient Temperature

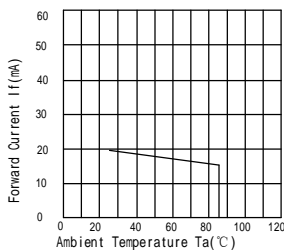

Relative Intensity vs. Ambient Temperature

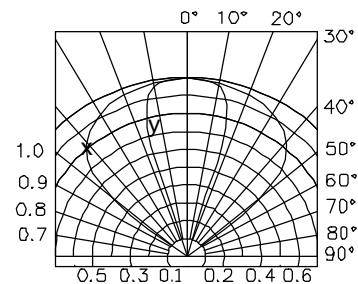
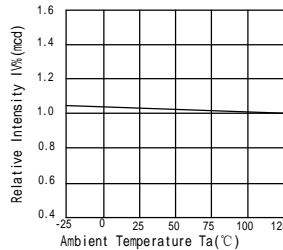

Forward Current vs. Forward Voltage

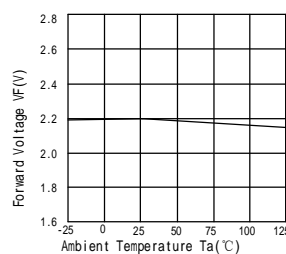
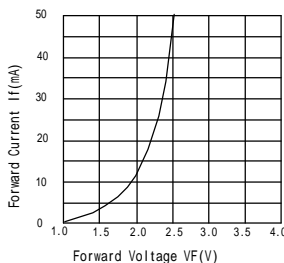
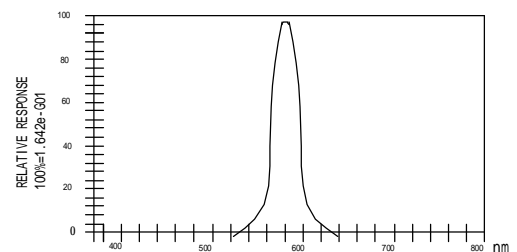
 Luminous Spectrum ($T_a=25^{\circ}\text{C}$) SPECTRAL RADIANCE

Soldering:

1. Manual Of Soldering

The temperature of the iron tip should not be higher than 300°C and Soldering within 3 seconds per solder-land is to be observed.

2. DIP soldering (Wave Soldering):

Preheating: 120°C~150°C, within 120~180 sec.

Operation heating: 245°C ± 5°C within 5 sec. 260°C (Max)

Gradual Cooling (Avoid quenching).

