

# PROFET™: Smart High-Side Switches



# General Introduction

Infineon's PROFET™ products are high-side switches placed between the supply and load in order to control the application. The high-side switches comprise a broad range of smart features, including diverse protection and diagnostic functions. Since the PROFET™ products are capable of addressing all kinds of resistive, capacitive and inductive loads, they can be used in a big variety of automotive, commercial, agricultural & industrial applications.

## Automotive Applications

- Lighting
  - Exterior and interior lighting (bulb/LED)
- Power Distribution
  - Relay & fuse replacement, solid state, relay,
  - Smart Power Distribution Center (PDC)
- Heating
  - Seat, PTC, auxiliary, glow plug
- Motor Control
  - DC brush motor, pumps, fans
- Infotainment



## Industrial Applications

- Automation/robotics
- General load management
- Electric drives
- Control systems/energy saving



The block diagram of the BTS500x0-1EGA shows the main functions and components of a PROFET™.

## Block Diagram BTS500x0-1EGA

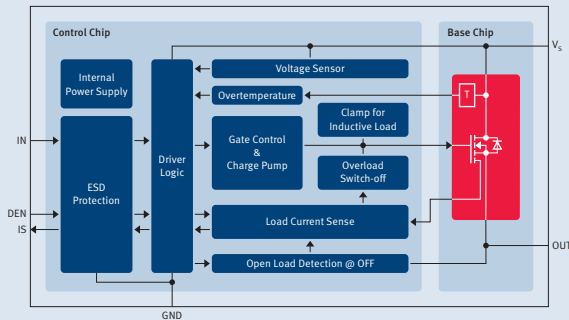

For more information about the PROFET™ family, the benefits and functionality of its protection and diagnosis features, please refer to [www.infineon.com/profet](http://www.infineon.com/profet).

# Family Overview

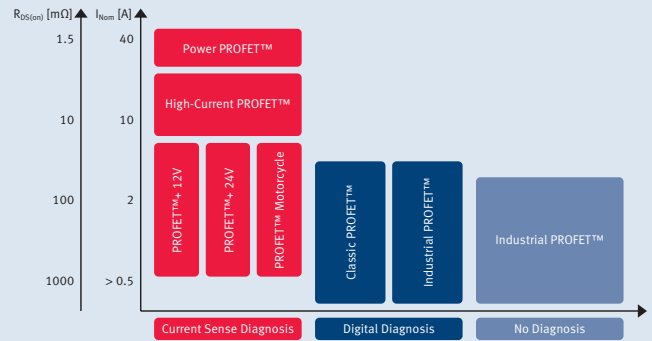

## Classic PROFET™

### Basic Features

- High-Side Switches for load currents between 0.25A and 12A
- Suitable for resistive, capacitive and inductive loads
- Wide operating voltage range
- On-state resistance between 2.5Ω and 20mΩ
- Improved electromagnetic compatibility (EMC)
- Protection: overtemperature, overvoltage, load dump, reverse polarity
- Diagnosis: open load in OFF detection, current sense (partially)

### Benefits

- Established and proven technology/products since more than 10 years
- Benchmark energy robustness
- High-voltage capability
- Fast switching capability
- Fast demagnetization of inductive loads

## PROFET™+ 12V & 24V

### Basic Features

- High-Side Switches for load currents between 0.5A and 10A
- Especially suitable for capacitive loads
- Operating voltage range:
  - PROFET™+ 12V: 5 – 28V
  - PROFET™+ 24V: 5 – 36V
- 3.3V and 5V compatible logic input
- PWM capability up to 200Hz (PROFET™+ 12V) or 400Hz (PROFET™+ 24V)
- Protection: overtemperature, overvoltage, load dump, reverse polarity, short-circuit
- Diagnosis: load current sense output

## Benefits

- Maximum design flexibility thanks to identical footprint
- Pin-compatibility between 12V and 24V and within each of the individual family members
- Very low stand-by current (< 0.5µA max.)
- High short-circuit robustness
- Outstanding current sense accuracy
- Improved heat dissipation of DSO package

## PROFET™ Motorcycle

### Basic Features

- Suitable for 2x 10W + 2W motorcycle left/right indicators
- Extended operating voltage range: 8–24V
- Minimum Load Dump protection: 65V
- Protected against overtemperature, overvoltage and short circuit/overload
- RoHS compliant & AEC qualified

### Benefits

- Autonomous frequency generation
- Reduced current consumption
- Ground-less device
- Rain function capability
- Smaller external capacitors
- Accurate flashing and bulb failure detection
- Small PG-DSO-8 package for reduced space requirements

## High-Current PROFET™

### Basic Features

- High-Side Switches for load currents up to 45A
- Suitable for resistive, capacitive and inductive loads
- Optimized for 12V and 24V supply voltages
- Current-driven and voltage-driven input logic
- On-state resistance from typically 20mΩ to 2.5mΩ
- PWM capability
- Very high energy capability up to 3 joules
- Protection: overtemperature, overvoltage, load dump, reverse polarity, short-circuit
- Diagnosis: load current sense output

### Benefits

- Efficient and robust drivers for High-Current loads
- Monitoring of load current
- Protection of device, wiring harness and load
- Available in standard power packages, such as DPAK and D<sup>2</sup>PAK

## Power PROFET™

### Basic Features

- High-Side Switches for load currents up to 40A
- Optimized for 12V supply voltage
- Voltage-driven input logic (3.3V and 5V)
- Stable behavior during cranking down to 3.2V supply voltage
- Lowest on-state resistance down to 1.0mΩ
- Protection: overtemperature, overvoltage, load dump, reverse polarity, short-circuit
- Diagnosis: load current sense output

### Benefits

- Efficient and robust drivers for High-Current loads
- Monitoring of load current
- Protection of device, wiring harness and load
- High short-circuit robustness (up to 100k cycles in accordance with AEC Q100-012)
- Available in standard power package (D<sup>2</sup>PAK)

## Industrial PROFET™

### Basic Features

- High-Side Switches for load currents between 0.25A and 4.5A
- Suitable for resistive, capacitive and inductive loads
- Maximum current limit typically at 3 times  $I_{nom}$
- Voltage-driven input logic (3.3V and 5V)
- On-state resistance 60mΩ up to 2.5Ω
- Industry qualification compliant
- Protection: overtemperature, short-circuit, reverse  $V_s$ , under-/overvoltage
- Diagnosis: short-circuit, overload, overtemperature, open load

### Benefits

- Efficient and robust load management for small and midsize current loads
- Digital diagnosis via status pin
- Protection of device, wiring harness and load
- High-voltage capability for industrial applications
- Freewheeling diode or active clamping on chip



## Current Sense, Current Input

### Basic Features

- 12V or 24V capable
- Single channel

### Protection Features

- Current limitation
- Overload protection
- Short-circuit shutdown
- ReverSave™
- Loss of GND

### Diagnosis Features

- Analog signal proportional to load current
- Overload detection
- Short-circuit detection

Product Type	Product Family	R <sub>DS(on)</sub> (typ) [mΩ]	R <sub>DS(on)</sub> (max.) @ T <sub>J</sub> = 150°C [mΩ]	Nominal Load Current [A]	E <sub>AS</sub> @ 20A [mJ]	Operating Voltage Range [V]	I <sub>L(SC)</sub> (typ) [A]	24V Capable	Short-circuit to GND Protection		Overtemperature Protection		Inverse Current Operation Capability	Open Load in ON Detection	Packages
									Latch	Restart	Latch	Restart			
BTS6163D	High-Current PROFET™	20.0	40	6.5	250	5.5 ... 62.0	70	●	●			●		●	PG-T0252-5
BTS443P	High-Current PROFET™	16.0	32	6.5	150	5.0 ... 36.0	65			●		●		●	PG-T0252-5
BTS5016SDA	High-Current PROFET™	16.0	32	6.5	120	5.5 ... 20.0	75		●			●		●	PG-T0252-5
BTS5014SDA	High-Current PROFET™	14.0	28	7.0	150	5.5 ... 20.0	80		●			●		●	PG-T0252-5
BTS5012SDA	High-Current PROFET™	12.0	24	8.0	200	5.5 ... 20.0	90		●			●		●	PG-T0252-5
BTS6142D	High-Current PROFET™	12.0	22	8.0	250	5.5 ... 24.0	100		●			●		●	PG-T0252-5
BTS6143D	High-Current PROFET™	10.0	18	10.0	300	5.5 ... 38.0	105		●			●		●	PG-T0252-5
BTS6133D	High-Current PROFET™	10.0	18	10.0	300	5.5 ... 38.0	105		●			●	●	●	PG-T0252-5
BTS50085-1TMA	High-Current PROFET™	9.0	17	11.0	1200	5.5 ... 58.0	90	●	●			●	●		PG-T0263-7
BTS50085-1TMB	High-Current PROFET™	9.0	17	11.0	1200	5.0 ... 58.0	90	●	●			●	●		PG-T0220-7
BTS50080-1TMA	High-Current PROFET™	8.0	16	12.0	400	5.5 ... 38.0	130		●			●		●	PG-T0263-7
BTS50080-1TMB	High-Current PROFET™	8.0	16	12.0	400	5.5 ... 38.0	130		●			●		●	PG-T0220-7
BTS50080-1TMC	High-Current PROFET™	8.0	16	12.0	400	5.5 ... 38.0	130		●			●		●	PG-T0263-7
BTS50080-1TEA	High-Current PROFET™	8.0	16	10.0	300	5.5 ... 30.0	125		●			●		●	PG-T0252-5
BTS50080-1TEB	High-Current PROFET™	8.0	16	10.0	300	5.5 ... 30.0	125		●			●	●	●	PG-T0252-5
BTS50070-1TMA	High-Current PROFET™	7.0	14	12.0	400	5.5 ... 30.0	95		●			●		●	PG-T0263-7
BTS50070-1TMB	High-Current PROFET™	7.0	14	12.0	400	5.5 ... 30.0	95		●			●		●	PG-T0220-7
BTS50055-1TMA	High-Current PROFET™	6.0	11	17.0	1500	5.0 ... 34.0	130		●			●	●		PG-T0263-7
BTS50055-1TMB	High-Current PROFET™	6.0	11	17.0	1500	5.0 ... 34.0	130		●			●	●		PG-T0220-7
BTS50055-1TMC	High-Current PROFET™	6.0	11	17.0	1500	5.5 ... 34.0	130			●		●	●		PG-T0263-7
BTS550P	High-Current PROFET™	3.5	6.5	35.0	3000	5.0 ... 34.0	220		●			●	●		PG-T0218-5
BTS555	High-Current PROFET™	2.5	4	45.0	3000	5.0 ... 34.0	400		●		●		●		PG-T0218-5

## Current Sense, Voltage Input

### Basic Features

- 12V or 24V capable
- Single or multi-channel

### Protection Features

- Short-circuit shutdown with auto-restart or latch
- Overtemperature shutdown with auto-restart or latch
- Reverse polarity protection by ReVerSave™ or with external components
- Loss of GND

### Diagnosis Features

- Analog signal proportional to load current
- Overload
- Open load in ON
- Overtemperature
- Short-circuit to GND

Product Type	Product Family	$R_{DS(on)}$ (typ) [mΩ]	$R_{DS(on)}$ (max) @ $T_J = 150^\circ\text{C}$ [mΩ]	Nominal Load Current [A]	$F_{AS}$ [m]	Operating Voltage Range [V]	$I_{L(SO)}$ (typ) [A]	Number of Channels		Overvoltage Shutdown	Sense Enable	Open Load in OFF	Latch	24V	ReVerSave™	Packages
								Limit	Trip							
Automotive Grade																
BTS5200-4EKA	PROFET™+ 12V	200.0	400.0	4 x 0.8	50 @ 0.5A	5.0 ... 28.0	7.3	4	●		●	●				PG-DSO-14 EP
BTS5180-2EKA	PROFET™+ 12V	180.0	360.0	2 x 1.0	30 @ 1A	5.0 ... 28.0	12	2	●		●	●				PG-DSO-14 EP
BTS5120-2EKA	PROFET™+ 12V	120.0	240.0	2 x 1.0	15 @ 2A	5.0 ... 28.0	12	2	●		●	●				PG-DSO-14 EP
BTS5090-2EKA	PROFET™+ 12V	90.0	180.0	2 x 2.0	42 @ 3A	5.0 ... 28.0	32	2	●		●	●				PG-DSO-14 EP
BTS5090-1EJA	PROFET™+ 12V	90.0	180.0	2.5	42 @ 3A	5.0 ... 28.0	32	1	●		●	●				PG-DSO-8 EP
BTS6110-1SJA	PROFET™ Motorcycle	80.0	200.0	2.0	n.a.	8.0 ... 24.0	27	1	●				●			PG-DSO-8
BTT6050-1EKA	PROFET™+ 24V	50.0	105.0	4.5	55 @ 4A	5.0 ... 48.0	47	1	●		●	●	●	●		PG-DSO-14 EP
BTS5045-2EKA	PROFET™+ 12V	45.0	90.0	2 x 2.5	35 @ 4A	5.0 ... 28.0	32	2	●		●	●				PG-DSO-14 EP
BTS5045-1EJA	PROFET™+ 12V	45.0	90.0	3.0	35 @ 4A	5.0 ... 28.0	32	1	●		●	●				PG-DSO-8 EP
BTS740S2	Classic PROFET™	30.0	60.0	4.0	370 @ 5.5A	5.0 ... 34.0	50	2	●	●						PG-DSO-20
BTS640S2G	Classic PROFET™	30.0	60.0	4.5	410 @ 12.6A	5.0 ... 34.0	50	1	●	●						PG-TO263-7
BTT6030-2EKA	PROFET™+ 24V	30.0	64.0	2 x 4.0	50 @ 4A	5.0 ... 48.0	70	2	●		●	●	●	●		PG-DSO-14 EP
BTT6030-1EKA	PROFET™+ 24V	30.0	64.0	6.0	50 @ 6A	5.0 ... 48.0	70	1	●		●	●	●	●		PG-DSO-14 EP
BTT6020-1EKA	PROFET™+ 24V	20.0	42.0	7.0	100 @ 7A	5.0 ... 48.0	88	1	●		●	●	●	●		PG-DSO-14 EP
BTS5030-2EKA	PROFET™+ 12V	30.0	60.0	2 x 3.0	50 @ 6A	5.0 ... 28.0	47	2	●		●	●				PG-DSO-14 EP
BTS5030-1EJA	PROFET™+ 12V	30.0	60.0	4.0	50 @ 6A	5.0 ... 28.0	47	1	●		●	●				PG-DSO-8 EP
BTS5020-2EKA	PROFET™+ 12V	20.0	40.0	2 x 4.0	75 @ 6A	5.0 ... 28.0	65	2	●		●	●				PG-DSO-14 EP
BTS5020-1EKA	PROFET™+ 12V	20.0	40.0	5.0	74 @ 6A	5.0 ... 28.0	65	1	●		●	●				PG-DSO-14 EP
BTS5016-2EKA	PROFET™+ 12V	16.0	32.0	2 x 5.0	95 @ 7A	5.0 ... 28.0	65	2	●		●	●				PG-DSO-14 EP
BTS5016-1EKB	PROFET™+ 12V	16.0	32.0	6.0	95 @ 7A	5.0 ... 28.0	65	1	●		●	●				PG-DSO-14 EP
BTS5012-1EKB	PROFET™+ 12V	12.0	24.0	8.0	110 @ 10A	5.0 ... 28.0	65	1	●		●	●				PG-DSO-14 EP
BTS5010-1EKB	PROFET™+ 12V	10.0	20.0	9.0	155 @ 10A	5.0 ... 28.0	65	1	●		●	●				PG-DSO-14 EP
BTS5008-1EKB	PROFET™+ 12V	8.0	16.0	10.0	160 @ 11A	5.0 ... 28.0	65	1	●		●	●				PG-DSO-14 EP
BTS50080-1EGA	High-Current PROFET™	8.0	16.0	13.0	125 @ 50A	6.0 ... 28.0	150	1		●	●	●			●	PG-DSO-12
BTS50070-1EGA	High-Current PROFET™	7.0	14.0	14.0	145 @ 50A	6.0 ... 28.0	150	1		●	●	●			●	PG-DSO-12
BTS50060-1EGA	High-Current PROFET™	6.0	12.0	15.0	170 @ 50A	6.0 ... 28.0	150	1		●	●	●			●	PG-DSO-12
BTS50060-1TEA	High-Current PROFET™	6.0	12.0	13.5	280 @ 20A	4.7 ... 28.0	75	1		●		●	●			PG-TO252-5
BTF50060-1TEA <sup>1)</sup>	High-Current PROFET™	6.0	12.0	13.5	280 @ 20A	4.7 ... 28.0	75	1		●		●	●			PG-TO252-5
BTS50050-1EGA	High-Current PROFET™	5.0	10.0	16.0	200 @ 50A	6.0 ... 28.0	150	1		●	●	●			●	PG-DSO-12
BTS50040-2SFA	High-Current PROFET™	4.0	8.2	2 x 11.0	411 @ 20A	6.0 ... 28.0	160	2		●		●			●	PG-DSO-36
BTS50015-1TAA	Power PROFET™	1.5	3.0	39.0	550 @ 33A	5.5 ... 28.0	135	1		●			●		●	PG-TO263-7

1) Speed PROFET™, capable for PWM up to 25kHz

## Digital Diagnosis

### Basic Features

- 12V or 24V capable
- Single or multi-channel

### Protection Features

- Overload protection
- Loss of battery / GND
- Short-circuit protection
- Overvoltage protection

### Diagnosis Features

- Open drain status feedback
- Overtemperature
- Open load
- Current limitation

Product Type	Product Family	$R_{DS(on)}$ (typ) [mΩ]	$R_{DS(on)}$ (max.) @ $T_j = 150^\circ\text{C}$ [mΩ]	Nominal Load Current [A]	$E_{AS}$ [mJ]	Operating Voltage Range [V]	$I_{L(SC)}$ (typ) [A]	Number of Channels	24V Capable	High-Current Limit	Low Current Limit	Overvoltage Shutdown	Short-circuit Diagnosis		Open Load in ON State	Packages
													to GND	to Battery		
<b>Automotive Grade</b>																
BSP742R	Classic PROFET™	350	700	0.4	800 @ 0.3A	5.0 ... 34.0	1.2	1			●		●	●		PG-DSO-8
BSP742R <sup>1)</sup>	Classic PROFET™	350	700	0.4	800 @ 0.3A	5.0 ... 34.0	1.2	1			●		●	●		PG-DSO-8
BTS4300SGA	Classic PROFET™	300	600	0.4	800 @ 0.3A	5.0 ... 34.0	1.2	1			●		●	●		PG-DSO-8
BSP752R	Classic PROFET™	200	380	1.7	125 @ 1A	6.0 ... 52.0	6.5	1	●	●			●	●		PG-DSO-8
BTS712N1	Classic PROFET™	200	400	1.0	150 @ 1.9A	5.0 ... 34.0	7.5	4		●		●		●		PG-DSO-20
BTS711L1	Classic PROFET™	200	400	1.0	150 @ 1.9A	5.0 ... 35.0	7.5	4		●		●			●	PG-DSO-20
BTS4880-R	Classic PROFET™	200	400	0.6	10000 @ 0.625A	11.0 ... 45.0	1.4	8	●				●			PG-DSO-36
BTS4175SGA	Classic PROFET™	175	350	1.3	125 @ 1A	6.0 ... 52.0	6.5	1	●	●			●	●		PG-DSO-8
BTS4160DGA	Classic PROFET™	160	320	1.0	65 @ 2.9A	5.5 ... 20.0	9.0	2		●				●		PG-DSO-14
BTS452R	Classic PROFET™	150	270	2.2	150 @ 1A	6.0 ... 52.0	6.5	1	●		●		●	●		PG-TO252-5
BTS5210G	Classic PROFET™	140	280	1.0	65 @ 2.9A	5.5 ... 40.0	9.0	2		●				●		PG-DSO-14
BTS5210L	Classic PROFET™	140	280	1.0	84 @ 2.9A	5.5 ... 40.0	9.0	2		●				●		PG-DSO-12
BTS716G	Classic PROFET™	140	280	1.0	76 @ 2.3A	5.5 ... 40.0	9.0	4		●				●		PG-DSO-20
BTS716GB	Classic PROFET™	140	280	1.0	76 @ 2.3A	5.5 ... 40.0	9.0	4		●				●		PG-DSO-20
BTS4130QGA	Classic PROFET™	130	260	1.0	76 @ 2.3A	5.5 ... 20.0	9.0	4		●				●		PG-DSO-20
BTS723GW	Classic PROFET™	105	210	2.0	110 @ 2.5A	7.0 ... 58.0	9.0	2	●		●		●	●		PG-DSO-14
BTS721L1	Classic PROFET™	100	200	2.0	300 @ 2.9A	5.0 ... 34.0	14.0	4		●		●		●		PG-DSO-20
BTS5215L	Classic PROFET™	90	180	2.0	178 @ 3.5A	5.5 ... 40.0	15.0	2		●				●		PG-DSO-12
BTS724G	Classic PROFET™	90	180	2.0	120 @ 3.3A	5.5 ... 40.0	15.0	4		●				●		PG-DSO-20
BTS428L2	Classic PROFET™	60	120	7.0	190 @ 7A	4.75 ... 41.0	22.0	1		●			●		●	PG-TO252-5
BTS432E2	High-Current PROFET™	38	70	11.0	1700 @ 20A	4.5 ... 42.0	44.0	1	●	●		●	●		●	PG-TO220-5
BTS432E2 E3062A	High-Current PROFET™	38	70	11.0	1700 @ 20A	4.5 ... 42.0	44.0	1	●	●		●	●		●	PG-TO263-5
BTS441R	Classic PROFET™	20	37	21.0	700 @ 21A	4.75 ... 41.0	65.0	1		●				●		PG-TO263-5
BTS442E2	High-Current PROFET™	18	35	21.0	2100 @ 20A	4.5 ... 42.0	95.0	1	●	●		●	●		●	PG-TO220-5
BTS442E2 E3062A	High-Current PROFET™	18	35	21.0	2100 @ 20A	4.5 ... 42.0	95.0	1	●	●		●	●		●	PG-TO263-5
<b>Industrial</b>																
ITS42K5D-EL <sup>3)</sup>	Industrial PROFET™	2500	8000	0.25	n.a. <sup>4)</sup>	4.5 ... 45.0	0.4	2	●	●		n.a.	●	●	●	PG-SSOP14
ITS42K5D-LD <sup>3)</sup>	Industrial PROFET™	2500	8000	0.25	n.a. <sup>4)</sup>	4.5 ... 45.0	0.4	2	●	●			●	●	●	PG-TSON10
ISP742R <sup>1)</sup>	Industrial PROFET™	350	700	0.4	800 @ 0.3A	5.0 ... 34.0	1.2	1	●		●		●	●		PG-DSO-8
ITS4300-SJ-D	Industrial PROFET™	300	480 <sup>2)</sup>	0.4	800 @ 0.3A	5.0 ... 34.0	1.2	1	●		●		●	●		PG-DSO-8
ITS4200S-SJ-D	Industrial PROFET™	200	350 <sup>2)</sup>	1.2	125 @ 1A	6.0 ... 52.0	6.5	1	●	●			●	●		PG-DSO-8
ITS42008-SB-D	Industrial PROFET™	200	320 <sup>2)</sup>	0.6	10000 @ 0.625A	11.0 ... 45.0	1.4	8	●				●			PG-DSO-36
ITS711L1	Industrial PROFET™	200	400	1.0	150 @ 1.9A	5.0 ... 35.0	7.5	4	●	●		●	●		●	PG-DSO-20
ITS716G	Industrial PROFET™	140	280	1.0	76 @ 2.3A	5.5 ... 40.0	9.0	4	●	●				●		PG-DSO-20
ITS724G	Industrial PROFET™	90	180	2.0	120 @ 3.3A	5.5 ... 40.0	15.0	4	●	●				●		PG-DSO-20
ITS5215L	Industrial PROFET™	90	180	2.0	178 @ 3.5A	5.5 ... 40.0	15.0	2	●	●				●		PG-DSO-12
ITS428L2	Industrial PROFET™	60	120	7.0	190 @ 7A	4.75 ... 41.0	22.0	1	●	●			●		●	PG-TO252-5

1) Inversed logic for diagnosis

2) at  $T_j = 125^\circ\text{C}$

3) Available in Q3/2014

4) Having freewheeling diode built in

## No Diagnosis

### Basic Features

- 12V or 24V capable
- Single channel

### Protection Features

- Short-circuit protection
- Current limitation
- Overvoltage protection
- Overtemperature protection

Product Type	Product Family	$R_{DS(on)}$ (typ) [mΩ]	$R_{DS(on)}$ (max.) @ $T_j = 150^\circ\text{C}$ [mΩ]	Nominal Load Current [A]	$E_{AS}$ [mJ]	Operating Voltage Range [V]	$I_{L(SO)}$ (typ) [A]	24V Capable	Package
<b>Automotive Grade</b>									
BTS4140N <sup>1)</sup>	Classic PROFET™	1000	3000	0.2	1000 @ 0.15A	4.9 ... 60.0	0.9	●	PG-SOT223-4
BSP742T	Classic PROFET™	350	700	1.1	100 @ 0.5A	5.0 ... 34.0	4.0		PG-DSO-8
BSP452	Classic PROFET™	200	400	0.7	500 @ 0.5A	5.0 ... 34.0	1.5		PG-SOT223-4
BTS452T	Classic PROFET™	200	380	2.2	150 @ 1A	6.0 ... 52.0	6.5	●	PG-TO252-5
BSP752T	Classic PROFET™	200	380	1.2	125 @ 1A	6.0 ... 52.0	6.5	●	PG-DSO-8
BTS4141N	Classic PROFET™	200	320	0.7	700 @ 0.7A	12.0 ... 45.0	2.1	●	PG-SOT223-4
BTS4142N	Classic PROFET™	200	320	1.4	160 @ 1A	12.0 ... 45.0	3.0	●	PG-SOT223-4
BSP762T	Classic PROFET™	100	200	2.4	870 @ 1A	5.0 ... 34.0	10.0		PG-DSO-8
BTS462T	Classic PROFET™	100	200	4.4	4400 @ 1A	5.0 ... 34.0	14.0		PG-TO252-5
BTS730	Classic PROFET™	70	140	3.0	n.a.	5.9 ... 16.9	20.0		PG-DSO-20
BSP772T	Classic PROFET™	60	120	3.1	900 @ 1.5A	5.0 ... 34.0	17.0		PG-DSO-8
BTS441T	Classic PROFET™	20	37	21.0	700 @ 21A	4.75 ... 41.0	65.0	●	PG-TO263-5
<b>Industrial</b>									
ITS41K0S	Industrial PROFET™	1000	3000 <sup>2)</sup>	0.2	1000 @ 0.15A	4.9 ... 60.0	0.9	●	PG-SOT223-4
ITS4200S-ME-N	Industrial PROFET™	200	400 <sup>2)</sup>	0.7	500 @ 0.5A	5.0 ... 34.0	1.5	●	PG-SOT223-4
ISP752T	Industrial PROFET™	200	380	1.3	125 @ 0.125A	6.0 ... 52.0	6.5	●	PG-DSO-8
ITS4141D	Industrial PROFET™	200	320	0.5	12000 @ 0.5A	12.0 ... 45.0	2.1	●	PG-TO252-5
ITS4200S-ME-O	Industrial PROFET™	200	320 <sup>2)</sup>	0.7	700 @ 0.5A	11.0 ... 45.0	3.0	●	PG-SOT223-4
ITS4200S-ME-P	Industrial PROFET™	200	320 <sup>2)</sup>	1.4	160 @ 1A	11.0 ... 45.0	3.0	●	PG-SOT223-4
ITS4100S	Industrial PROFET™	100	200 <sup>2)</sup>	2.4	870 @ 1A	5.0 ... 34.0	10.0	●	PG-DSO-8
ITS4060S	Industrial PROFET™	60	120 <sup>2)</sup>	3.1	900 @ 1.5A	5.0 ... 34.0	17.0	●	PG-DSO-8

1) Current-controlled input

2) at  $T_j = 125^\circ\text{C}$



## Ask Infineon. Get connected with the answers.

Infineon offers its toll-free 0800/4001 service hotline as one central number, available 24/7 in English, Mandarin and German.

Our global connection service goes way beyond standard switchboard services by offering qualified support on the phone. Call us!





■ Germany	0800 951 951 951 (German/English)
■ China, mainland	4001 200 951 (Mandarin/English)
■ India	000 800 4402 951 (English)
■ USA	1-866 951 9519 (English/German)
■ Other countries	00* 800 951 951 951 (English/German)
■ Direct access	+49 89 234-0 (interconnection fee, German/English)

\* Please note: Some countries may require you to dial a code other than "00" to access this international number, please visit [www.infineon.com/service](http://www.infineon.com/service) for your country!

## Where to Buy

Infineon Distribution Partners and  
Sales Offices:  
[www.infineon.com/WhereToBuy](http://www.infineon.com/WhereToBuy)

## Stay connected

-  [www.facebook.com/infineon](http://www.facebook.com/infineon)
-  [www.google.com/+infineon](http://www.google.com/+infineon)
-  [www.twitter.com/infineon](http://www.twitter.com/infineon)
-  [www.infineon.com/linkedin](http://www.infineon.com/linkedin)
-  [www.infineon.com/xing](http://www.infineon.com/xing)
-  [www.youtube.com/infineon](http://www.youtube.com/infineon)

Infineon Technologies – innovative semiconductor solutions  
for energy efficiency, mobility and security.

Published by Infineon Technologies AG

© 2014 Infineon Technologies AG. All Rights Reserved.

Order Number: B127-H9861-G1-X-7600  
05 / 2014

# Mouser Electronics

Authorized Distributor

Click to View Pricing, Inventory, Delivery & Lifecycle Information:

[Infineon:](#)

[BTS441RS](#) [BTS452T](#) [BTS441RSXK](#)