



FEATURES:

- RoHS compliant
- High efficiency up to 84%
- Remote On/Off Control
- 8 pin SIP package
- Operating temperature -40°C to + 85°C
- Continuous Short circuit protection
- Wide 2:1 input range
- Input/Output Isolation 1600 & 3000VDC



Models Single output

Model	Input Voltage (V)	Output Voltage (V)	Output Current max (mA)	Isolation (VDC)	Capacitor Load (µF)	Efficiency
AM3G-0503SZ	4.5-9	3.3	700	1600	2200	74
AM3G-0505SZ	4.5-9	5	600	1600	1000	76
AM3G-0512SZ	4.5-9	12	250	1600	470	82
AM3G-0515SZ	4.5-9	15	200	1600	220	82
AM3G-1203SZ	9-18	3.3	700	1600	2200	76
AM3G-1205SZ	9-18	5	600	1600	1000	81
AM3G-1212SZ	9-18	12	250	1600	470	84
AM3G-1215SZ	9-18	15	200	1600	220	84
AM3G-2403SZ	18-36	3.3	700	1600	2200	74
AM3G-2405SZ	18-36	5	600	1600	1000	79
AM3G-2412SZ	18-36	12	250	1600	470	82
AM3G-2415SZ	18-36	15	200	1600	220	84
AM3G-4803SZ	36-72	3.3	700	1600	2200	75
AM3G-4805SZ	36-72	5	600	1600	1000	78
AM3G-4812SZ	36-72	12	250	1600	470	81
AM3G-4815SZ	36-72	15	200	1600	220	81
AM3G-0503SH30Z	4.5-9	3.3	700	3000	2200	74
AM3G-0505SH30Z	4.5-9	5	600	3000	1000	76
AM3G-0512SH30Z	4.5-9	12	250	3000	470	82
AM3G-0515SH30Z	4.5-9	15	200	3000	220	82
AM3G-1203SH30Z	9-18	3.3	700	3000	2200	76
AM3G-1205SH30Z	9-18	5	600	3000	1000	81
AM3G-1212SH30Z	9-18	12	250	3000	470	84
AM3G-1215SH30Z	9-18	15	200	3000	220	84
AM3G-2403SH30Z	18-36	3.3	700	3000	2200	74
AM3G-2405SH30Z	18-36	5	600	3000	1000	79
AM3G-2412SH30Z	18-36	12	250	3000	470	82
AM3G-2415SH30Z	18-36	15	200	3000	220	84
AM3G-4803SH30Z	36-72	3.3	700	3000	2200	75
AM3G-4805SH30Z	36-72	5	600	3000	1000	78
AM3G-4812SH30Z	36-72	12	250	3000	470	81
AM3G-4815SH30Z	36-72	15	200	3000	220	81

Models Dual output

Model	Input Voltage (V)	Output Voltage (V)	Output Current max (mA)	Isolation (VDC)	Capacitor Load (µF)	Efficiency (%)
AM3G-0505DZ	4.5-9	±5	±300	1600	±470	77
AM3G-0512DZ	4.5-9	±12	±125	1600	±220	81
AM3G-0515DZ	4.5-9	±15	±100	1600	±100	82
AM3G-1205DZ	9-18	±5	±300	1600	±470	80
AM3G-1212DZ	9-18	±12	±125	1600	±220	83
AM3G-1215DZ	9-18	±15	±100	1600	±100	82
AM3G-2405DZ	18-36	±5	±300	1600	±470	80
AM3G-2412DZ	18-36	±12	±125	1600	±220	83
AM3G-2415DZ	18-36	±15	±100	1600	±100	83
AM3G-4805DZ	36-72	±5	±300	1600	±470	78

Models Dual output (continued)

Model	Input Voltage (V)	Output Voltage (V)	Output Current max (mA)	Isolation (VDC)	Capacitor Load (µF)	Efficiency (%)
AM3G-4812DZ	36-72	±12	±125	1600	±220	80
AM3G-4815DZ	36-72	±15	±100	1600	±100	81
AM3G-0505DH30Z	4.5-9	±5	±300	3000	±470	77
AM3G-0512DH30Z	4.5-9	±12	±125	3000	±220	81
AM3G-0515DH30Z	4.5-9	±15	±100	3000	±100	82
AM3G-1205DH30Z	9-18	±5	±300	3000	±470	80
AM3G-1212DH30Z	9-18	±12	±125	3000	±220	83
AM3G-1215DH30Z	9-18	±15	±100	3000	±100	82
AM3G-2405DH30Z	18-36	±5	±300	3000	±470	80
AM3G-2412DH30Z	18-36	±12	±125	3000	±220	83
AM3G-2415DH30Z	18-36	±15	±100	3000	±100	83
AM3G-4805DH30Z	36-72	±5	±300	3000	±470	78
AM3G-4812DH30Z	36-72	±12	±125	3000	±220	80
AM3G-4815DH30Z	36-72	±15	±100	3000	±100	81

NOTE: All specifications in this datasheet are measured at an ambient temperature of 25°C, humidity<75%, nominal input voltage and at rated output load unless otherwise specified

Input Specifications

Parameters	Nominal	Typical	Maximum	Units
Voltage range	5 12 24 48	5-9 9-18 18-36 36-72		VDC
Filter	Capacitor			
Turn on Transient process time		300		µs
Transient Response deviation			±3	%
Start up time		20		ms
Absolute Maximum Rating	5 Vin 12 Vin 24 Vin 48 Vin	-0.7-15 -0.7-36 -0.7-50 -0.7-100		VDC
Peak Input Voltage time			100	ms
On/Off Control	ON – high impedance or open; OFF – 3-6mA input current through 1KΩ (standby 3mA max)			
Input reflected ripple current*		35		mA p-p

* The input reflected ripple current should be measured with connected 12µH inductor and 47µF input capacitor (ESR<1Ω at 100 KHz)

Isolation Specifications

Parameters	Conditions	Typical	Rated	Units
Tested I/O voltage	3 sec	1600 & 3000		VDC
Resistance		> 1000		MOhm
Capacitance		680		pF

Output Specifications

Parameters	Conditions	Typical	Maximum	Units
Voltage accuracy		±1		%
Cross Regulation (Dual)	25% load on one output and 100% load on second output	±5		%
Short Circuit protection		Continuous		
Short Circuit restart		Auto recovery		
Line voltage regulation	LL~HL	±0.5		%
Load voltage regulation	load 25~100%	±1		%
Temperature coefficient		±0.02		%/°C
Ripple & Noise	At 20MHz Bandwidth	75		mV p-p

General Specifications

Parameters	Conditions	Typical	Maximum	Units
Switching frequency	100% load	>100		KHz
Operating temperature	Full Load without Derating	-40 to +71		°C
Storage temperature		-40 to +125		°C
Max Case temperature			+100	°C
Cooling	Free air convection			
Humidity			95	%
Case material	Non-conductive black plastic			
Potting material	Epoxy (UL94V-0 rated)			
Pin Material	C5191R-H Solder coated			
Weight		4.8		g
Dimensions (L x W x H)		0.86 x 0.36 x 0.42 inch	21.85 x 9.20 x 10.60 mm	
MTBF		>2 465 000 hrs (MIL-HDBK -217F, Ground Benign, t=+25°C)		

Safety Specifications

Parameters	
Agency Approval	CE
Standards	EN55022 Class A, EN55024
	IEC61000-4-2, Perf. Criteria B
	IEC61000-4-3, Perf. Criteria A
	IEC61000-4-4, Perf. Criteria B (external 220uF/100V cap required)
	IEC61000-4-5, Perf. Criteria B (external 220uF/100V cap required)
	IEC61000-4-6, Perf. Criteria A
	IEC61000-4-8, Perf. Criteria A

Pin Out Specifications

Pin	1600 & 3000VDC	
	Single	Dual
1	- V Input	- V Input
2	+ V Input	+ V Input
3	On/Off Control	On/Off Control
5	N.C.	N.C.
6	+ V Output	+ V Output
7	- V Output	Common
8	N.C.	- V Output

Dimensions

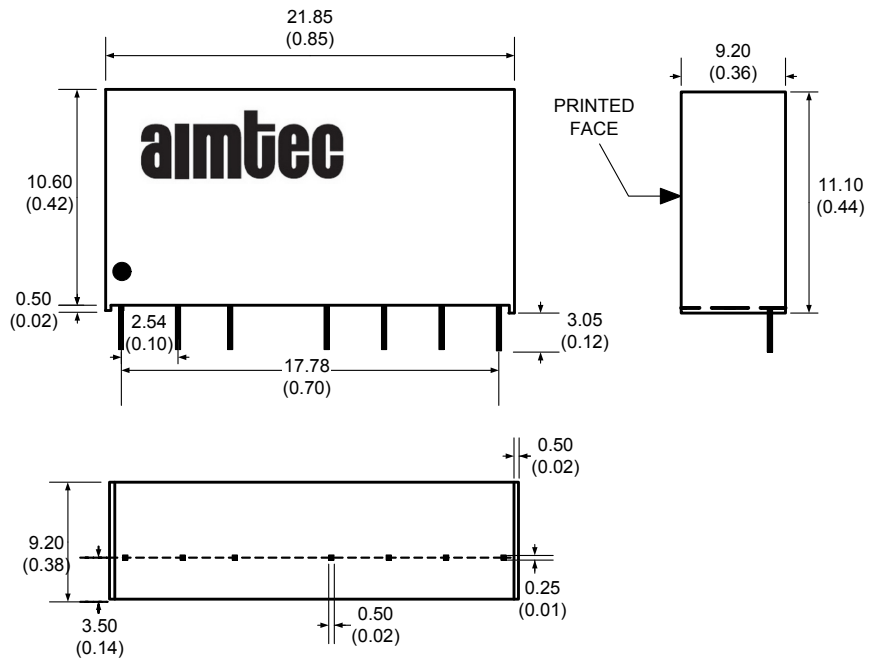

Conducted Emissions:

Input Voltage	C1	L1
5V	220uF/25V	5.6uH
12V Single	100uF/100V	18 uH
12V Dual	2.2uF/100V	18uH
24V	10uF/35V	18uH
48V	100uF/100V	56uH

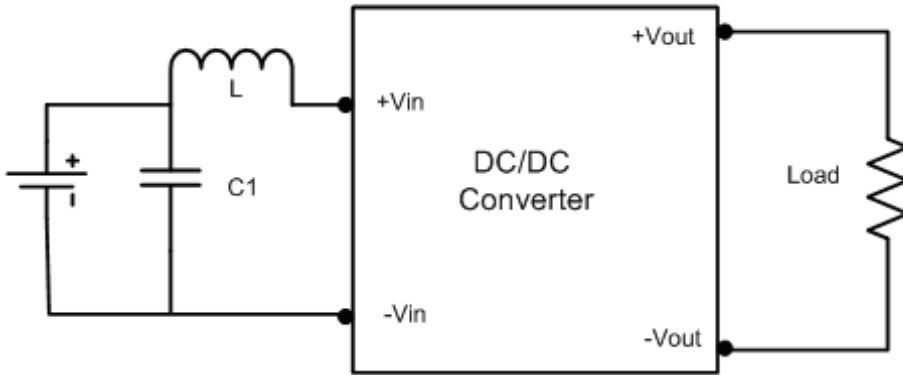

Surge:

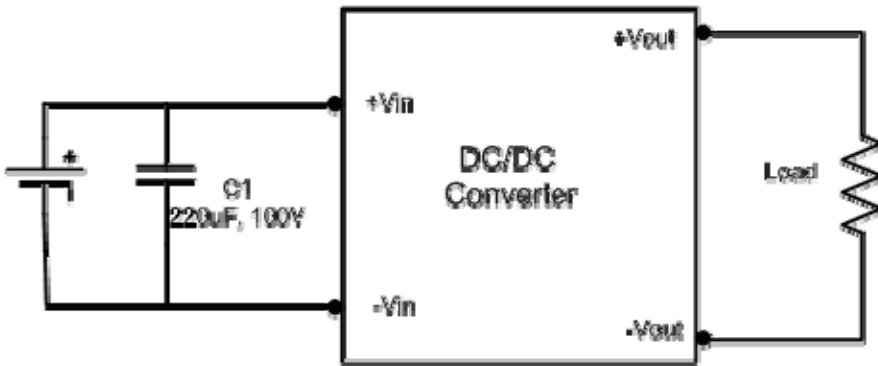

Derating:

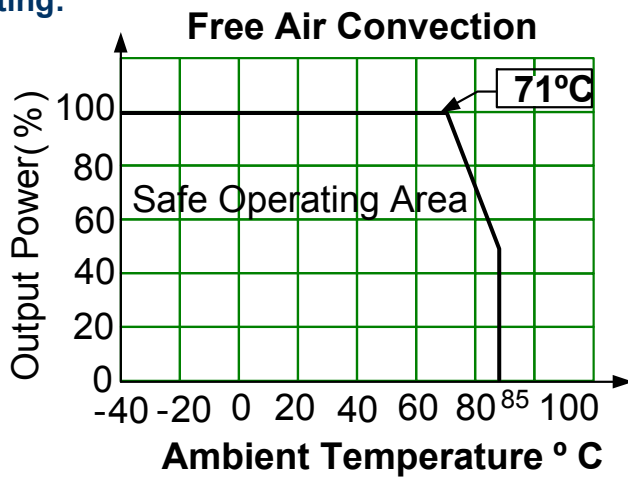

Control ON/OFF pin connection example:

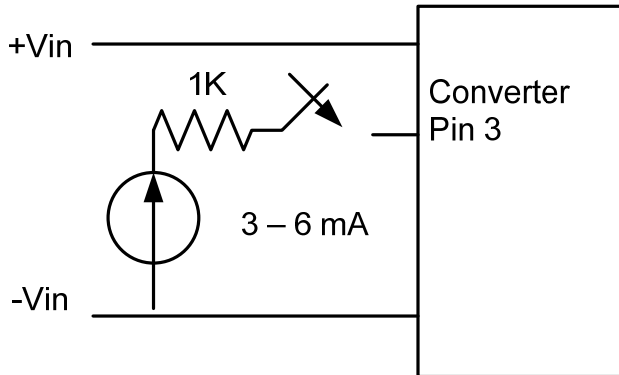

The voltage could be applied through a limiting resistor. The converter is turned on the external switching circuit is open.

NOTE: 1. Datasheets are updated as needed and as such, specifications are subject to change without notice. Once printed or downloaded, datasheets are no longer controlled by Aimtec; refer to www.aimtec.com for the most current product specifications. 2. Product labels shown, including safety agency certifications on labels, may vary based on the date manufactured. 3. Mechanical drawings and specifications are for reference only. 4. All specifications are measured at an ambient temperature of 25°C, humidity<75%, nominal input voltage and at rated output load unless otherwise specified. 5. Aimtec may not have conducted destructive testing or chemical analysis on all internal components and chemicals at the time of publishing this document. CAS numbers and other limited information are considered proprietary and may not be available for release. 6. This product is not designed for use in critical life support systems, equipment used in hazardous environments, nuclear control systems or other such applications which necessitate specific safety and regulatory standards other the ones listed in this datasheet. 7. Warranty is in accordance with Aimtec's standard Terms of Sale available at www.aimtec.com.