

# Chip Inductors (Chip Coils) for High Frequency Vertical Wire Wound

## LQW2BH\_03 Series (0805 Size)

### Dimension

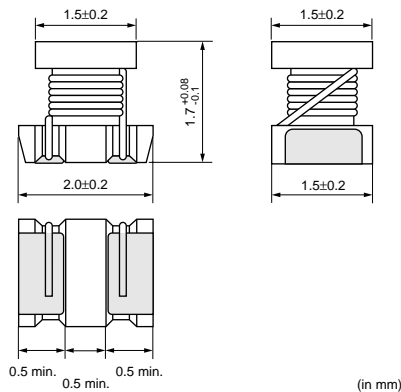

### Packaging

Code	Packaging	Minimum Quantity
L	180mm Embossed Tape	2000
K	330mm Embossed Tape	7500

### Rated Value (□: packaging code)

Part Number	Inductance	Test Frequency	Rated Current	Max. of DC Resistance	Q (min.)	Test Frequency	Self Resonance Frequency (min.)
LQW2BHN3N3D03□	3.3nH±0.5nH	100MHz	910mA	0.05ohm	10	250MHz	6000MHz
LQW2BHN6N8D03□	6.8nH±0.5nH	100MHz	680mA	0.11ohm	20	250MHz	5400MHz
LQW2BHN8N2D03□	8.2nH±0.5nH	100MHz	630mA	0.12ohm	20	250MHz	3900MHz
LQW2BHN10NJ03□	10nH±5%	100MHz	1320mA	0.03ohm	30	250MHz	3300MHz
LQW2BHN12NJ03□	12nH±5%	100MHz	680mA	0.11ohm	30	250MHz	3200MHz
LQW2BHN15NJ03□	15nH±5%	100MHz	630mA	0.12ohm	30	250MHz	2700MHz
LQW2BHN18NJ03□	18nH±5%	100MHz	690mA	0.10ohm	30	250MHz	2600MHz
LQW2BHN22NJ03□	22nH±5%	100MHz	720mA	0.09ohm	30	250MHz	2100MHz
LQW2BHN27NJ03□	27nH±5%	100MHz	540mA	0.17ohm	40	250MHz	2300MHz
LQW2BHN33NG03□	33nH±2%	100MHz	570mA	0.15ohm	40	250MHz	1900MHz
LQW2BHN33NJ03□	33nH±5%	100MHz	570mA	0.15ohm	40	250MHz	1900MHz
LQW2BHN39NG03□	39nH±2%	100MHz	730mA	0.09ohm	40	250MHz	1700MHz
LQW2BHN39NJ03□	39nH±5%	100MHz	730mA	0.09ohm	40	250MHz	1700MHz
LQW2BHN47NG03□	47nH±2%	100MHz	450mA	0.23ohm	40	200MHz	1600MHz
LQW2BHN47NJ03□	47nH±5%	100MHz	450mA	0.23ohm	40	200MHz	1600MHz
LQW2BHN56NG03□	56nH±2%	100MHz	430mA	0.26ohm	40	200MHz	1500MHz
LQW2BHN56NJ03□	56nH±5%	100MHz	430mA	0.26ohm	40	200MHz	1500MHz
LQW2BHN68NG03□	68nH±2%	100MHz	460mA	0.23ohm	40	200MHz	1200MHz
LQW2BHN68NJ03□	68nH±5%	100MHz	460mA	0.23ohm	40	200MHz	1200MHz
LQW2BHN82NG03□	82nH±2%	100MHz	320mA	0.42ohm	40	150MHz	1100MHz
LQW2BHN82NJ03□	82nH±5%	100MHz	320mA	0.42ohm	40	150MHz	1100MHz
LQW2BHNR10G03□	100nH±2%	100MHz	270mA	0.55ohm	35	150MHz	900MHz
LQW2BHNR10J03□	100nH±5%	100MHz	350mA	0.38ohm	40	150MHz	900MHz
LQW2BHNR12G03□	120nH±2%	100MHz	320mA	0.40ohm	40	150MHz	750MHz

Operating Temperature Range: -40°C to +85°C

Continued on the following page.

● This data sheet is applied for CHIP INDUCTORS (CHIP COILS) used for General Electronics equipment for your design.

### Note:

1. This datasheet is downloaded from the website of Murata Manufacturing co., ltd. Therefore, it's specifications are subject to change or our products in it may be discontinued without advance notice. Please check with our sales representatives or product engineers before ordering.
2. This datasheet has only typical specifications because there is no space for detailed specifications. Therefore, please approve our product specifications or transact the approval sheet for product specifications before ordering.

 Continued from the preceding page.

Part Number	Inductance	Test Frequency	Rated Current	Max. of DC Resistance	Q (min.)	Test Frequency	Self Resonance Frequency (min.)
LQW2BHNR12J03□	120nH±5%	100MHz	320mA	0.40ohm	40	150MHz	750MHz
LQW2BHNR15G03□	150nH±2%	100MHz	260mA	0.68ohm	30	150MHz	350MHz
LQW2BHNR15J03□	150nH±5%	100MHz	390mA	0.47ohm	30	150MHz	350MHz
LQW2BHNR18G03□	180nH±2%	100MHz	250mA	0.71ohm	35	100MHz	700MHz
LQW2BHNR18J03□	180nH±5%	100MHz	250mA	0.71ohm	35	100MHz	700MHz
LQW2BHNR22G03□	220nH±2%	100MHz	240mA	0.70ohm	35	100MHz	500MHz
LQW2BHNR22J03□	220nH±5%	100MHz	240mA	0.70ohm	35	100MHz	500MHz
LQW2BHNR27J03□	270nH±5%	10MHz	190mA	2.00ohm	15	25.2MHz	550MHz
LQW2BHNR27K03□	270nH±10%	10MHz	190mA	2.00ohm	15	25.2MHz	550MHz
LQW2BHNR33J03□	330nH±5%	10MHz	180mA	2.20ohm	15	25.2MHz	500MHz
LQW2BHNR33K03□	330nH±10%	10MHz	180mA	2.20ohm	15	25.2MHz	500MHz
LQW2BHNR39J03□	390nH±5%	10MHz	170mA	2.50ohm	15	25.2MHz	400MHz
LQW2BHNR39K03□	390nH±10%	10MHz	170mA	2.50ohm	15	25.2MHz	400MHz
LQW2BHNR47J03□	470nH±5%	10MHz	160mA	2.80ohm	15	25.2MHz	350MHz
LQW2BHNR47K03□	470nH±10%	10MHz	160mA	2.80ohm	15	25.2MHz	350MHz

Operating Temperature Range: -40°C to +85°C

### ■ Q - Frequency Characteristics (Typ.)

LQW2BH\_03

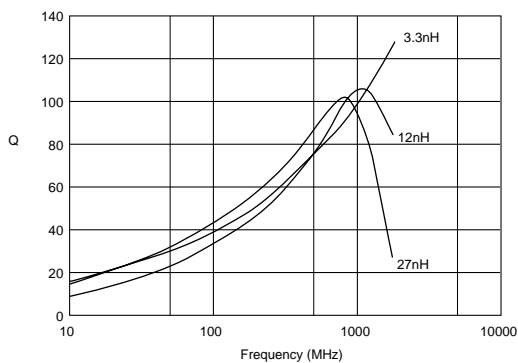

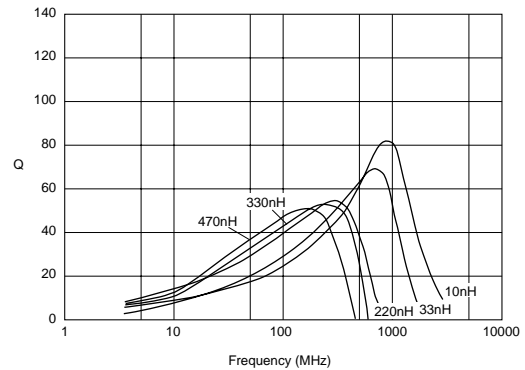

### ■ Q - Frequency Characteristics (Typ.)

LQW2BH\_03

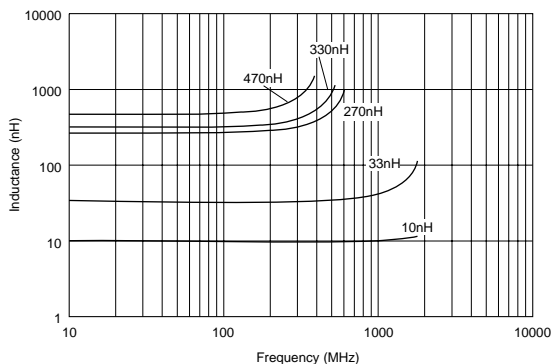

### ■ Inductance - Frequency Characteristics (Typ.)



Continued on the following page. 

● This data sheet is applied for CHIP INDUCTORS (CHIP COILS) used for General Electronics equipment for your design.

#### ⚠ Note:

1. This datasheet is downloaded from the website of Murata Manufacturing co., Ltd. Therefore, it's specifications are subject to change or our products in it may be discontinued without advance notice. Please check with our sales representatives or product engineers before ordering.
2. This datasheet has only typical specifications because there is no space for detailed specifications. Therefore, please approve our product specifications or transact the approval sheet for product specifications before ordering.

 Continued from the preceding page.

### ■ Caution/Notice

#### Caution (Rating)

Do not use products beyond the rated current as this may create excessive heat.

#### Notice

Solderability of Tin plating termination chip might be deteriorated when low temperature soldering profile where peak solder temperature is below the Tin melting point is used. Please confirm the solderability of Tin plating termination chip before use.

● This data sheet is applied for CHIP INDUCTORS (CHIP COILS) used for General Electronics equipment for your design.

#### Note:

1. This datasheet is downloaded from the website of Murata Manufacturing co., Ltd. Therefore, it's specifications are subject to change or our products in it may be discontinued without advance notice. Please check with our sales representatives or product engineers before ordering.
2. This datasheet has only typical specifications because there is no space for detailed specifications. Therefore, please approve our product specifications or transact the approval sheet for product specifications before ordering.