



**RoHS**

**HL-LB001D74W-5B5C3(Ra1) White**

# Specification

Client Name :

客户名称 : \_\_\_\_\_

Client P/N :

客户品号 : \_\_\_\_\_

Product P/N :

产品型号 : HL--LB001D74W-5B5C3(Ra1)

Sending Date: \_\_\_\_\_

Client approval 客户审核			Hongli approval 鸿利光电审核		
Approval 核准	Audit 确认	Confirmation 制作	Approval 核准	Audit 确认	Confirmation 制作
<input type="checkbox"/> Qualified 接受		<input type="checkbox"/> Disqualified 不接受		DATE: 日期:	

Adr : Airport High-tech Industry Base Jinggu South Road(XianKe 1st Road Intersection), Huadu District, Guangzhou, China

地址 : 中国广州市花都区机场高新科技产业基地金谷南路与先科一路交汇

Tel/电话 : 020-86733333

Fax/传真 : 020-86733883 86733938

86733265

Web/网址 : www.honglitronic.com

注:1. 此规格书以中英文方式书写,若有冲突以中文版本为准文本.

2. 此规格书的最终解释权归广州市鸿利光电股份有限公司

3. 此规格书的有效期限为两年,自盖章或签字之日起计算,期满时双方可以续签协议,但应采用书面形式

## HL-LB001D74W-5B5C3(Ra1) White



**ATTENTION**  
OBSERVE PRECAUTIONS  
FOR HANDLING  
ELECTROSTATIC  
DISCHARGE  
SENSITIVE  
DEVICES

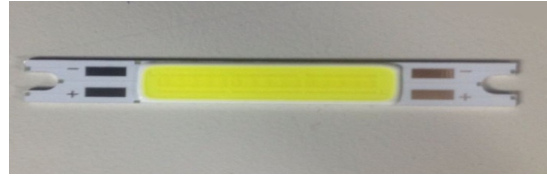

### Features

- Dimension: 50mm×7mm×1.8mm
- Single color.
- Emitting Color: White
- Easy installation with screws.
- Package: 100pcs/white box.
- High efficiency.
- Low power consumption.
- Long operating lifespan.
- High heat dissipation efficiency.
- RoHS compliant.

### Description

The White source color devices are made with GaN on sapphire White Light Emitting Diode.

### Applications

- Reading Lamp.
- Street Lamp.
- LED Backlight.
- Energy Saving Lamp.
- Decorative and Entertainment Lighting.
- Indoor and Outdoor Commercial Lighting.

### Package Dimensions

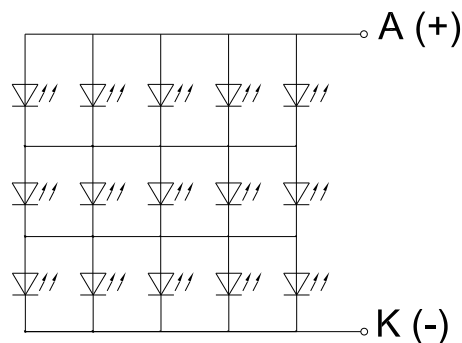
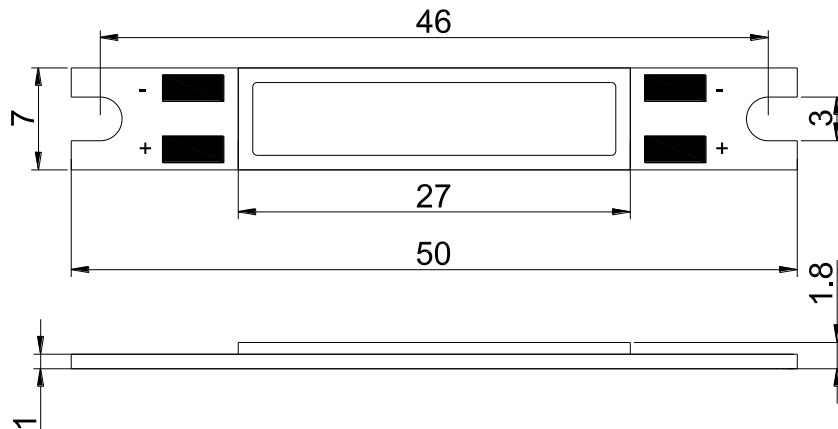

#### Notes:

1. All dimension units are millimeters.
2. All dimension tolerance is  $\pm 0.2\text{mm}$  unless otherwise noted.

**HL-LB001D74W-5B5C3(Ra1) White**

# Specifications规范

## (1) Absolute Maximum Ratings at Ta=25°C绝对最大额定值在25°C

Parameter参数	Symbol符号	Rating 值	Units单位
Input power 输入功率	Pi	5.4	W
Maximum operating current 最大工作电流	IF <sub>max</sub>	600	mA
Junction Temperature结温	Tj	115	°C
Operating Temperature Range工作温度	Topr	-20°C To +75°C	
Storage Temperature Range储藏温度	Tstg	-40°C To +100°C	
Lead Soldering Temperature*引线焊接温度	T <sub>SOL</sub>	Max. 350°C for 5sec Max.	

Note (注意):

1.The temperature of Aluminum PCB do not exceed **75°C**.

基板负极引线温度不能超过**75°C**

2.When hand soldering, keep the temperature of iron below less **350°C less than 5seconds**

当手工焊接时,烙铁的温度必须**小于350°C**,时间**不能超过5秒**

## (2) Optical Characteristics at Ta=25°C IF=500mA

典型的光学特性在Ta 25°C IF=500mA

HL-LB001D74W-5B5C3 ( Ra1 )					
CCT (K)	Ra	Min (lm)	Typ (lm)	Max (lm)	LM/W (min)
3000	70	430	470	—	85
4000	70	450	490	—	90
5000	70	460	500	—	90
5700	70	480	520	—	95
6000/6500	70	480	520	—	95

Note:

1.The tolerance of measurement at our tester is **Vf+/-3%** , **Φv+/-10%** and **Ra+/-2**.测试仪测量的公差在电压±3% , 流明±10% 和显指±2

2.All high power LED products mounted on Aluminum substrate can be lighted directly, but we do not recommend lighting

the high power products for more than 5 seconds without a appropriate heat dissipation equipment.

所有高功率LED产品必须安装在散热板上点亮,同时我们不建议在没有一个合适的散热器时,点亮本产品超过5秒。

## (3) Optical Electrical /Thermal Characteristics at Ta=25° IF=500mA

典型的电学/热学特性在Ta=25°C IF=500mA

IF (mA)	VF (V)			R (j-s) (°C/W)	Po (W)
	min	typ	max		
500	8.5	10	11.5	4	5

## HL-LB001D74W-5B5C3(Ra1) White

### Typical Optical and Electrical Characteristics Curves

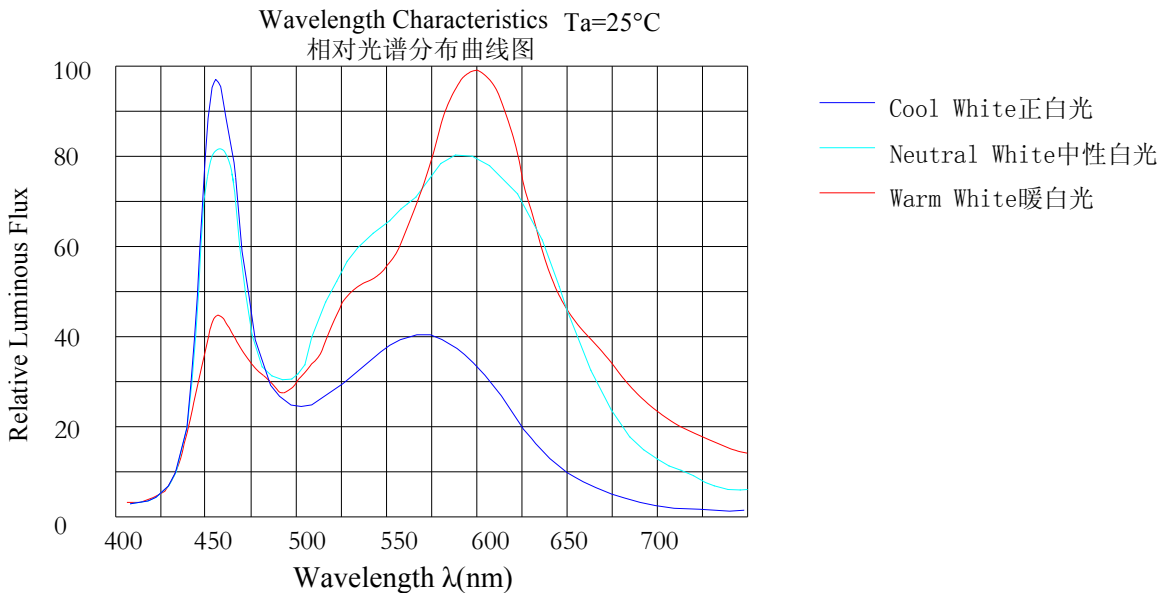
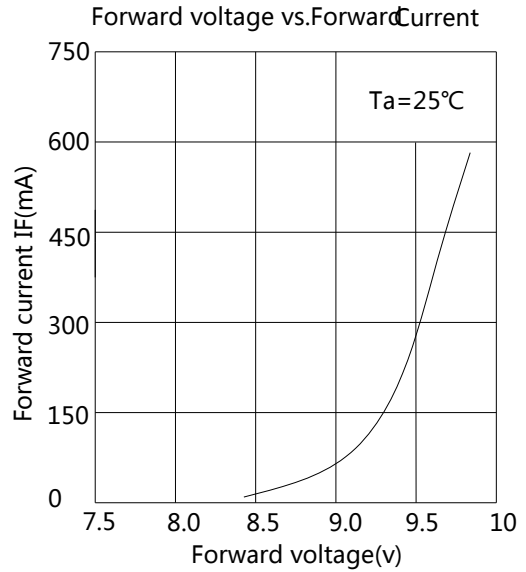
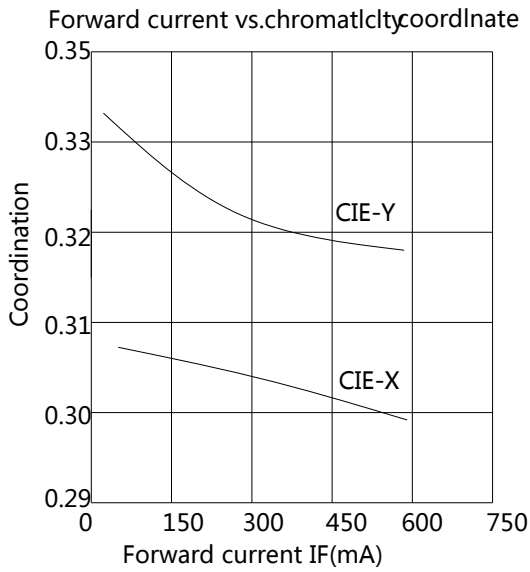
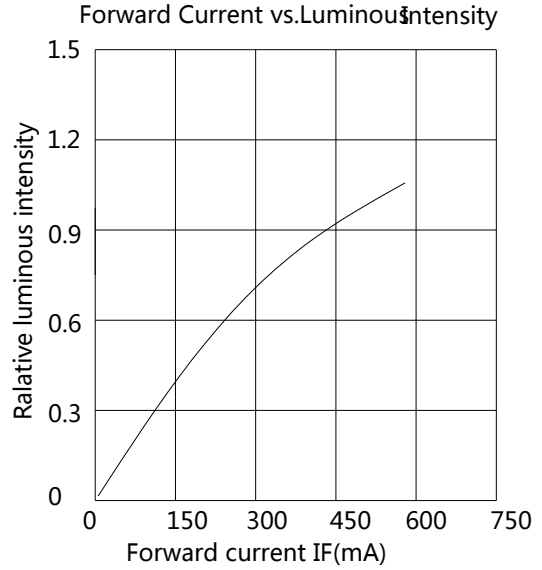
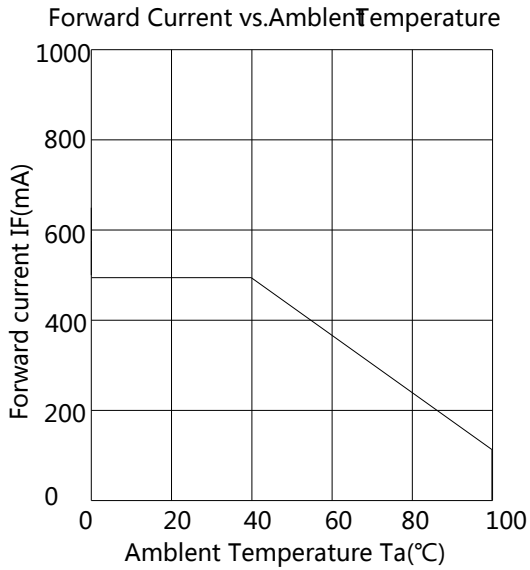

## HL-LB001D74W-5B5C3(Ra1) White

### Spatial Distribution Graph

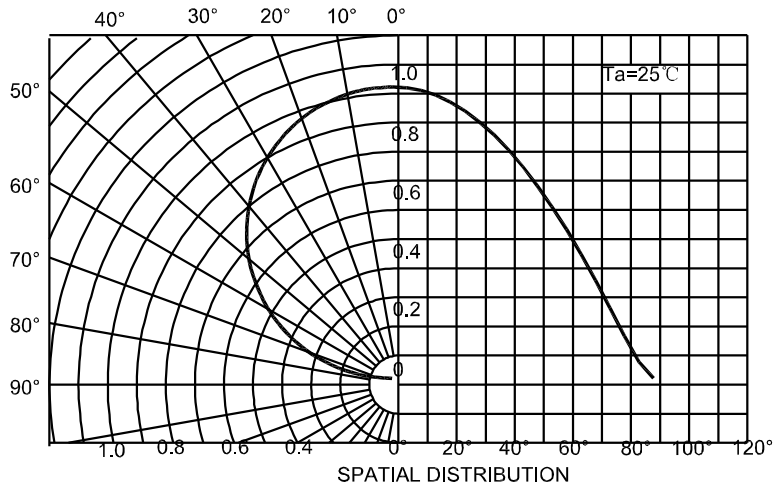

### Product Thermal Application Information

When assembling on PCB or heatsink carrier, thermal grease should be evenly spreaded with a thickness <math>< 100\mu\text{m}</math>.

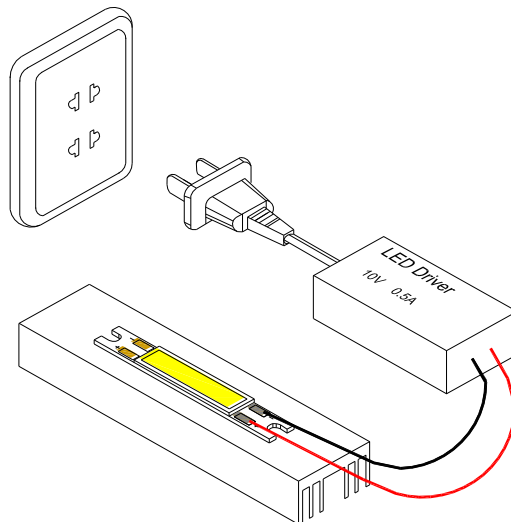
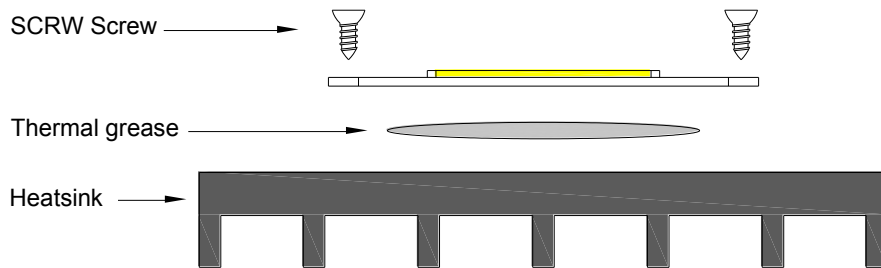

**HL-LB001D74W-5B5C3(Ra1) White**

**Tape Specifications**

(Units : mm)

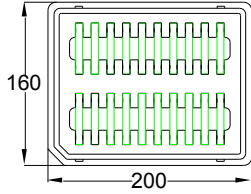

Tray:20PCS

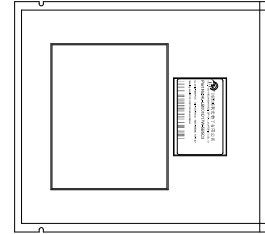
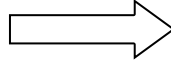

1Tray/ESD Shielding Bag:20PCS

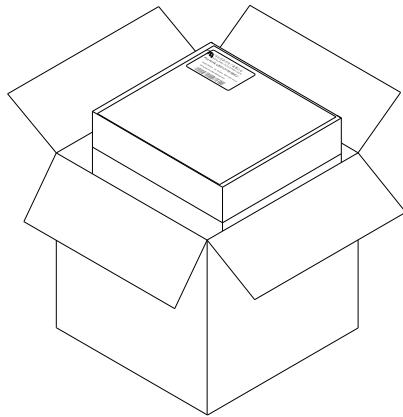

5Inner Box/Outer Box:500PCS

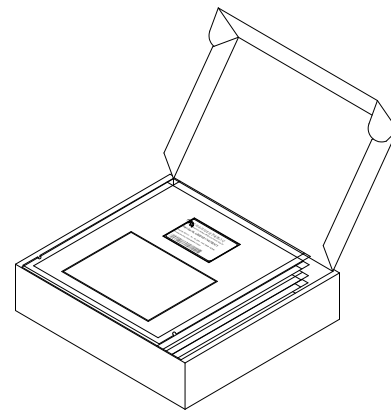
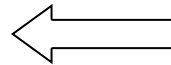

5Bags/Inner Box:100PCS

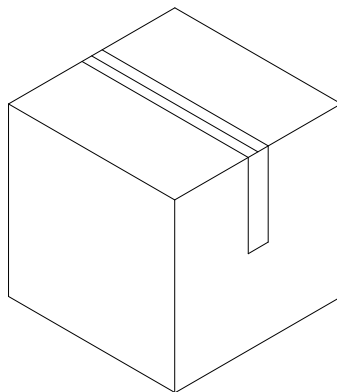

Outer Box:500PCS

**Note:**

1.Package storage condition will be limited temperature 20~30 °C.