

Keysight 2-Port and 4-Port PNA Network Analyzer

N5221B 10 MHz to 13.5 GHz

N5222B 10 MHz to 26.5 GHz

Data Sheet and
Technical
Specifications for
Option 210 and 410

Documentation Warranty

THE MATERIAL CONTAINED IN THIS DOCUMENT IS PROVIDED "AS IS," AND IS SUBJECT TO BEING CHANGED, WITHOUT NOTICE, IN FUTURE EDITIONS. FURTHER, TO THE MAXIMUM EXTENT PERMITTED BY APPLICABLE LAW, KEYSIGHT DISCLAIMS ALL WARRANTIES, EITHER EXPRESS OR IMPLIED WITH REGARD TO THIS MANUAL AND ANY INFORMATION CONTAINED HEREIN, INCLUDING BUT NOT LIMITED TO THE IMPLIED WARRANTIES OF MERCHANTABILITY AND FITNESS FOR A PARTICULAR PURPOSE. KEYSIGHT SHALL NOT BE LIABLE FOR ERRORS OR FOR INCIDENTAL OR CONSEQUENTIAL DAMAGES IN CONNECTION WITH THE FURNISHING, USE, OR PERFORMANCE OF THIS DOCUMENT OR ANY INFORMATION CONTAINED HEREIN. SHOULD KEYSIGHT AND THE USER HAVE A SEPARATE WRITTEN AGREEMENT WITH WARRANTY TERMS COVERING THE MATERIAL IN THIS DOCUMENT THAT CONFLICT WITH THESE TERMS, THE WARRANTY TERMS IN THE SEPARATE AGREEMENT WILL CONTROL.

U.S. Government Rights

U.S. Government Rights. The Software is "commercial computer software," as defined by Federal Acquisition Regulation ("FAR") 2.101. Pursuant to FAR 12.212 and 27.405-3 and Department of Defense FAR Supplement ("DFARS") 227.7202, the U.S. government acquires commercial computer software under the same terms by which the software is customarily provided to the public. Accordingly, Keysight provides the Software to U.S. government customers under its standard commercial license, which is embodied in its End User License Agreement (EULA), a copy of which can be found at <http://www.keysight.com/find/sweula>. The license set forth in the EULA represents the exclusive authority by which the U.S. government may use, modify, distribute, or disclose the Software. The EULA and the license set forth therein, does not require or permit, among other things, that Keysight: (1) Furnish technical information related to commercial computer software or commercial computer software documentation that is not customarily provided to the public; or (2) Relinquish to, or otherwise provide, the government rights in excess of these rights customarily provided to the public to use, modify, reproduce, release, perform, display, or disclose commercial computer software or commercial computer software documentation. No additional government requirements beyond those set forth in the EULA shall apply, except to the extent that those terms, rights, or licenses are explicitly required from all providers of commercial computer software pursuant to the FAR and the DFARS and are set forth specifically in writing elsewhere in the EULA. Keysight shall be under no obligation to update, revise or otherwise modify the Software. With respect to any technical data as defined by FAR 2.101, pursuant to FAR 12.211 and 27.404.2 and DFARS 227.7102, the U.S. government acquires no greater than Limited Rights as defined in FAR 27.401 or DFARS 227.7103-5 (c), as applicable in any technical data.

Corrected System Performance	6
System Dynamic Range and Receiver Dynamic Range.....	6
Table 1a. System Dynamic Range and Receiver Dynamic Range, N5221B, Option 210, 410.....	7
Table 1b. System Dynamic Range and Receiver Dynamic Range, N5222B, Option 210, 410.....	7
Corrected System Performance, Option 210, 410.....	8
Table 2a. N5221B and N5222B with 85052B Calibration Kit - Specification	8
Table 2b. N5221B and N5222B with N4691B 2-Port Electronic Calibration Module	10
Table 2c. N5221B and N5222B with N4433A 4-Port Electronic Calibration Module.....	11
Uncorrected System Performance	13
Table 3a. Error Terms (dB), All Ports, Option 210, 410 - Specifications	13
Table 3b. Error Terms (dB), All Ports, Option 210, 410 - Typical	14
Test Port Output.....	14
Table 4. Frequency Information, Option 210, 410	14
Table 5. Maximum Leveled Power (dBm), Option 210, 410	15
Table 6. Power Level Accuracy (dB), Option 210, 410.....	15
Table 7a. Power Level Linearity (dB).....	15
Table 7b. Power Level Linearity (dB).....	16
Table 8. Power Sweep Range (dB), Option 210, 410.....	16
Table 9. Nominal (Preset) Power (dBm).....	16
Table 10. Power Resolution and Maximum/Minimum Settable Power.....	17
Table 11. 2 nd and 3 rd Harmonics at Max Specified Power (dBc).....	17
Table 12. Non-Harmonic Spurs at Nominal Power (dBc),.....	17
Table 13. Phase Noise (dBc/Hz), Option 210, 410 - Typical	18
Test Port Input	19
Table 14. Test Port Noise Floor (dBm) @ 10 Hz IFBW, Option 210, 410.....	19
Table 15. 0.1 dB Receiver Compression at Test Port (dBm)	19
Table 16. Receiver Compression at Test Port Power - Specification	20
Table 17. Trace Noise Magnitude (dB rms).....	20
Table 18. Trace Noise Phase (deg rms).....	21
Table 19. Reference Level Magnitude, Option 210, 410 - Specification.....	21
Table 20. Stability vs. Temperature, Option 210, 410 - Typical	21
Table 21. Stability vs. Time, Option 210, 410 - Specification	22
Table 22. Damage Input Level.....	22

Dynamic Accuracy	23
Table 23. N5221B and N5222B Dynamic Accuracy	23
Table 24. Group Delay - Typical.....	26
General Information	27
Table 25. Miscellaneous Information	28
Table 26. Front Panel Information, Option 210, 410	28
Table 27. Rear Panel Information, Option 210, 410	29
Table 28. Analyzer Dimensions and Weight	33
Regulatory and Environmental Information	33
Measurement Throughput Summary	34
Table 29a. Typical Cycle Time (ms) for Measurement Completion, All Models and Options	34
Table 29b. N5221B Typical Cycle Time (ms) for Full-Span Measurement Completion.....	35
Table 29c. N5222B Typical Cycle Time (ms) for Full-Span Measurement Completion	35
Table 30. Cycle Time vs. IF Bandwidth - Typical	36
Table 31. Cycle Time vs. Number of Points - Typical	37
Table 32. Data Transfer Time (ms) - Typical.....	38
Test Set Block Diagrams.....	39
N5221B and N5222B Option 210 (2-port metrology configuration).....	39
N5221B and N5222B Option 410 (4-port metrology configuration).....	39
Receiver Block Diagram	40

This is a complete list of the technical specifications for the N5221B and N5222B PNA Series network analyzers with the following options:

2-Port Model

Option 210 – 2-port, single source, with metrology configuration

4-Port Model

Option 410 – 4-port, dual source, with metrology configuration.

See block diagrams on page 39.

Notes

This document provides technical specifications for the 85052B, N4691B and N4433A calibration kits.

Please download our free Uncertainty Calculator from http://www.keysight.com/find/na_calculator to generate the curves for your calibration kit and PNA setup.

For all tables in this data sheet, the specified performance at the exact frequency of a break is the degraded value of the two specifications at that frequency.

Definitions

All specifications and characteristics apply over a 25 °C ±5 °C range (unless otherwise stated) and 90 minutes after the instrument has been turned on.

Specification (spec.): Warranted performance. Specifications include guardbands to account for the expected statistical performance distribution, measurement uncertainties, and changes in performance due to environmental conditions.

Characteristic (char.): A performance parameter that the product is expected to meet before it leaves the factory, but that is not verified in the field and is not covered by the product warranty. A characteristic includes the same guardbands as a specification.

Typical (typ.): Expected performance of an average unit which does not include guardbands. It is not covered by the product warranty.

Nominal (nom.): A general, descriptive term that does not imply a level of performance. It is not covered by the product warranty.

Calibration: The process of measuring known standards to characterize a network analyzer's systematic (repeatable) errors.

Corrected (residual): Indicates performance after error correction (calibration). It is determined by the quality of calibration standards and how well "known" they are, plus system repeatability, stability, and noise.

Uncorrected (raw): Indicates instrument performance without error correction. The uncorrected performance affects the stability of a calibration.

Standard: When referring to the analyzer, this includes no options unless noted otherwise.

Corrected System Performance

The specifications in this section apply for measurements made with the N5221B and N5222B PNA network analyzers with the following conditions:

- 10 Hz IF bandwidth
- No averaging applied to data
- Isolation calibration with an averaging factor of 8

System Dynamic Range and Receiver Dynamic Range

- **System Dynamic Range** is defined as the specified source maximum output power (spec) minus the noise floor (spec).
- **Extended Dynamic Range at Direct Access Input** is defined as the specified source maximum output power (spec) minus the direct receiver access input noise floor (spec).
- **Receiver Dynamic Range** is defined as the test port compression at 0.1 dB (typical) minus the noise floor (typical).

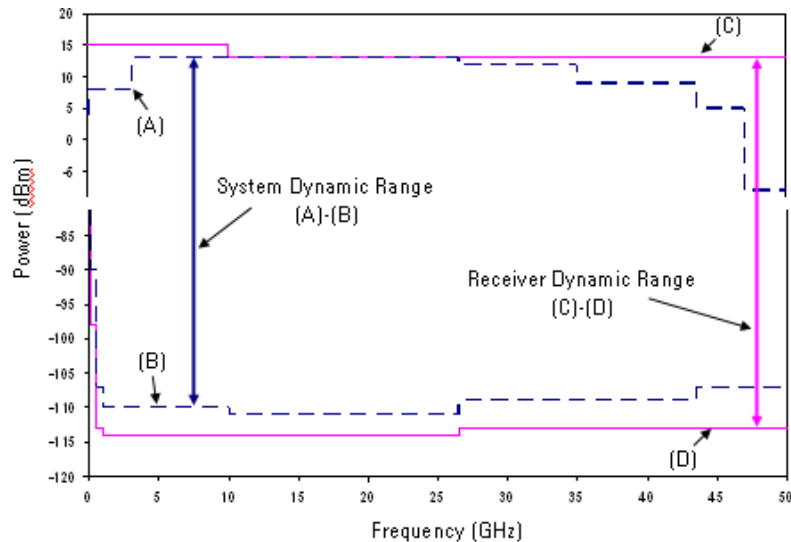

NOTE

The effective dynamic range must take measurement uncertainties and interfering signals into account. This set-up should only be used when the receiver input will never exceed its maximum receiver input. When the analyzer is in segment sweep mode, it can have predefined frequency segments which will output a higher power level when the extended dynamic range is required (i.e. devices with high insertion loss), and reduced power when the maximum receiver input level will occur (i.e. devices with low insertion loss). The extended range is only available in one-path transmission measurements.

It may typically be degraded at particular frequencies below 500 MHz due to spurious receiver residuals.

Table 1a. System Dynamic Range and Receiver Dynamic Range, N5221B, Option 210, 410

Description	Specification			Typical			
	System Dynamic Range (dB) (A)-(B)	Max Leveled Output Power (dBm) (A)	Test Port Noise Floor (dBm) (B)	System Dynamic Range (dB)	Receiver Dynamic Range (dB) (C)-(D)	0.1 dB Compression at Test Port (dBm) (C)	Test Port Noise Floor (dBm) (D)
10 MHz to 50 MHz	88	6	-82	102	103	15	-88
50 MHz to 100 MHz	102	7	-95	117	118	15	-103
100 MHz to 500 MHz	112	7	-105	124	122	12	-110
500 MHz to 2 GHz	121	7	-114	132	130	12	-118
2 GHz to 3.2 GHz	121	7	-114	133	131	12	-119
3.2 GHz to 13.5 GHz	121	7	-114	135	131	12	-119

Table 1b. System Dynamic Range and Receiver Dynamic Range, N5222B, Option 210, 410

Description	Specification			Typical			
	System Dynamic Range (dB) (A)-(B)	Max Leveled Output Power (dBm) (A)	Test Port Noise Floor (dBm) (B)	System Dynamic Range (dB)	Receiver Dynamic Range (dB) (C)-(D)	0.1 dB Compression at Test Port (dBm) (C)	Test Port Noise Floor (dBm) (D)
10 MHz to 50 MHz	88	6	-82	102	103	15	-88
50 MHz to 100 MHz	102	7	-95	117	118	15	-103
100 MHz to 500 MHz	112	7	-105	124	122	12	-110
500 MHz to 2 GHz	121	7	-114	132	130	12	-118
2 GHz to 3.2 GHz	121	7	-114	133	131	12	-119
3.2 GHz to 13.5 GHz	121	7	-114	135	131	12	-119
13.5 GHz to 20 GHz	121	7	-114	134	132	12	-120
20 GHz to 24 GHz	118	7	-111	130	128	10	-118
24 GHz to 26.5 GHz	108	1	-107	124	126	10	-116

Corrected System Performance, Option 210, 410

For any S_{ii} reflection measurement:

- $S_{jj} = 0$.

For any S_{ij} transmission measurement:

- $S_{ji} = S_{ij}$ when $S_{ij} \leq 1$
- $S_{ji} = 1/S_{ij}$ when $S_{ij} > 1$
- $S_{kk} = 0$ for all k

Applies to the N5221B/2A Option 210 or 410 analyzers, 85131F flexible test port cable set, and a full 2-port calibration. Also applies to the following condition:

Environmental temperature $23^\circ \pm 3^\circ \text{C}$, with $< 1^\circ \text{C}$ deviation from calibration temperature

Table 2a. N5221B and N5222B with 85052B Calibration Kit - Specification

Description	Specification (dB)					
	10 MHz to 50 MHz	50 MHz to 500 MHz	500 MHz to 2 GHz	2 GHz to 13.5 GHz	13.5 GHz to 20 GHz	20 GHz to 26.5 GHz
Directivity	48	48	48	44	44	44
Source Match	40	40	40	31	31	31
Load Match	48	48	48	44	44	44
Reflection Tracking						
Mag	0.003	0.003	0.003	0.006	0.006	0.006
Phase	0.020	0.020	0.020	0.040	0.040	0.040
Transmission Tracking						
Mag	0.006	0.006	0.007	0.046	0.058	0.095
Phase	0.043	0.038	0.049	0.306	0.385	0.626

Transmission Uncertainty

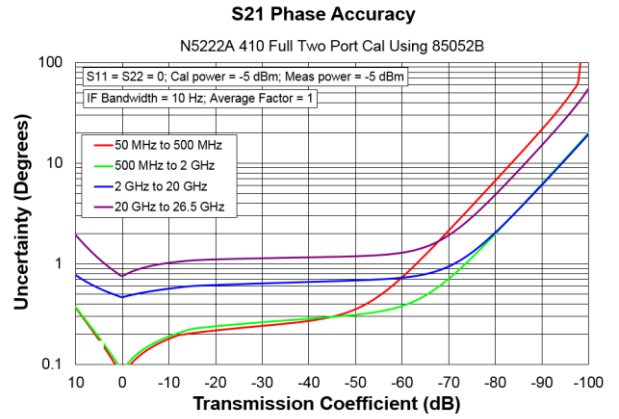
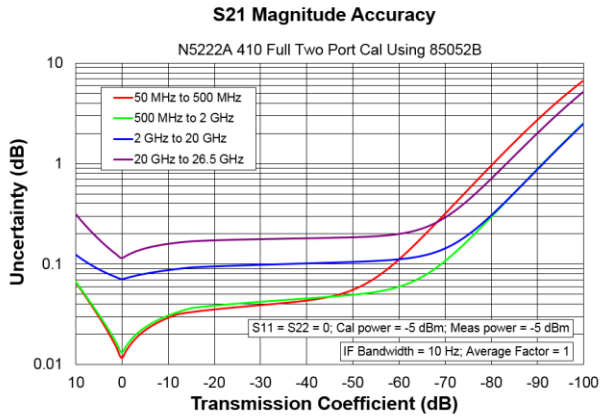

Reflection Uncertainty

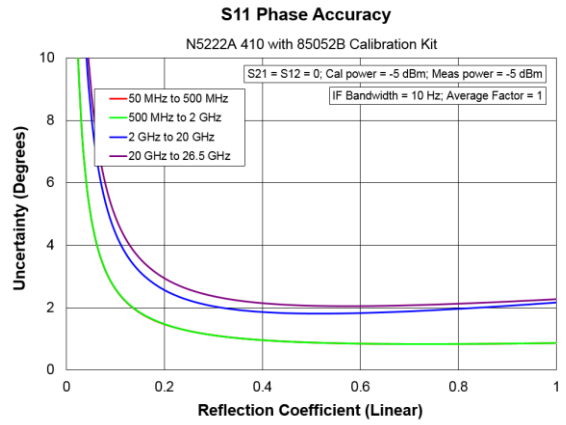
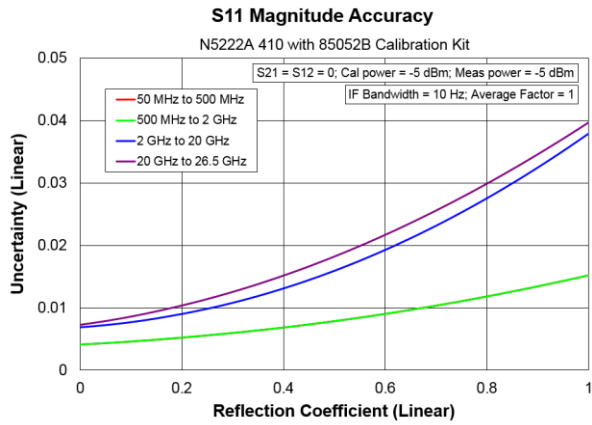
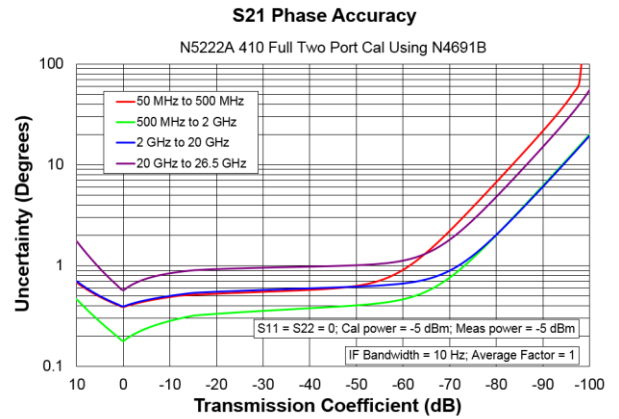
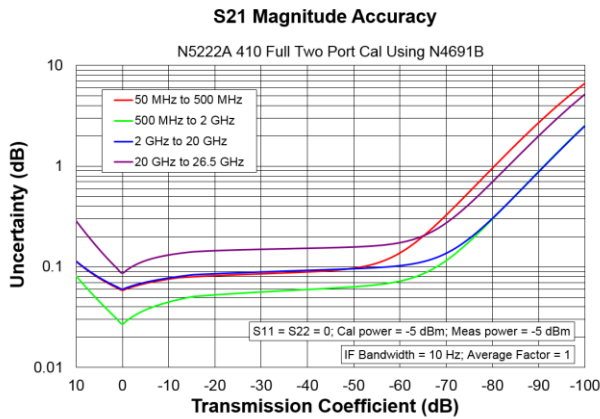

Table 2b. N5221B and N5222B with N4691B 2-Port Electronic Calibration Module

Description	Specification (dB)					
	10 MHz to 50 MHz	50 MHz to 500 MHz	500 MHz to 2 GHz	2 GHz to 13.5 GHz	13.5 GHz to 20 GHz	20 GHz to 26.5 GHz
Directivity	41	46	56	48	48	44
Source Match	36	41	47	44	44	40
Load Match	36	41	47	43	43	39
Reflection Tracking						
Mag	0.060	0.050	0.020	0.040	0.040	0.050
Phase	0.396	0.330	0.132	0.264	0.264	0.330
Transmission Tracking						
Mag	0.065	0.052	0.021	0.045	0.047	0.067
Phase	0.428	0.344	0.138	0.300	0.309	0.444

Transmission Uncertainty



Reflection Uncertainty

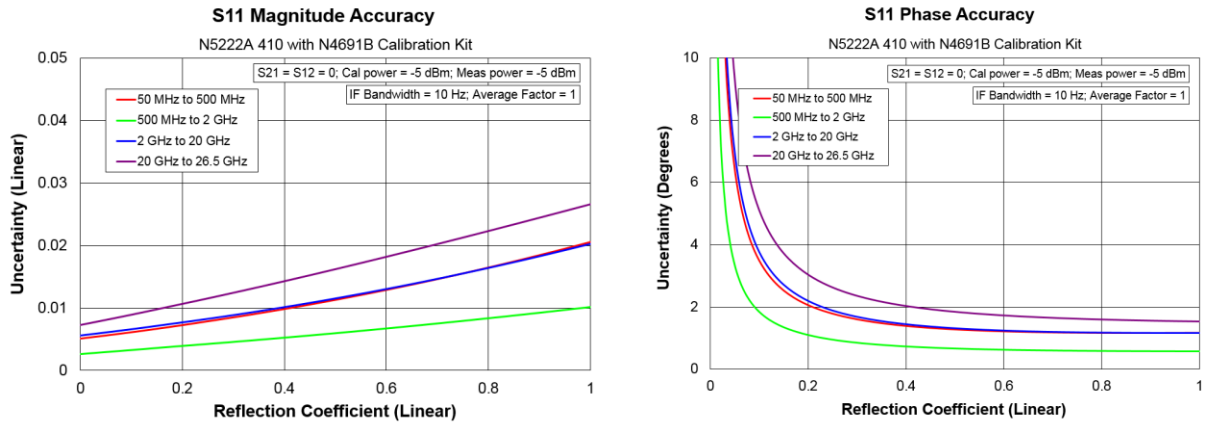

Table 2c. N5221B and N5222B with N4433A 4-Port Electronic Calibration Module

NOTE

Uncertainty curves for the N4433A are created using a 2-port calibration. Multiport uncertainties are not supported at this time.

Description	Specification (dB)				
	10 MHz to 50 MHz	50 MHz to 500 MHz	500 MHz to 2 GHz	2 GHz to 13.5 GHz	13.5 GHz to 20 GHz
Directivity	45	52	52	45	45
Source Match	36	42	42	37	31
Load Match	36	42	42	36	30
Reflection Tracking					
Mag	0.100	0.060	0.060	0.100	0.180
Phase	0.660	0.396	0.396	0.660	1.188
Transmission Tracking					
Mag	0.103	0.061	0.061	0.108	0.190
Phase	0.680	0.403	0.405	0.710	1.251

Transmission Uncertainty

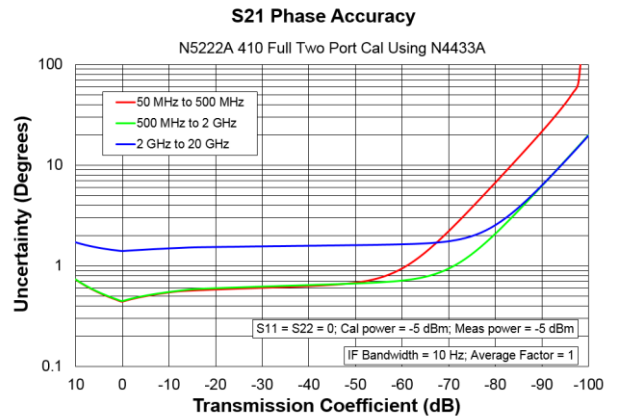
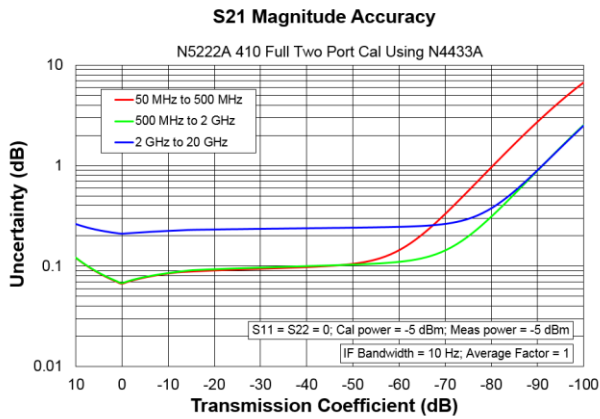

Reflection Uncertainty

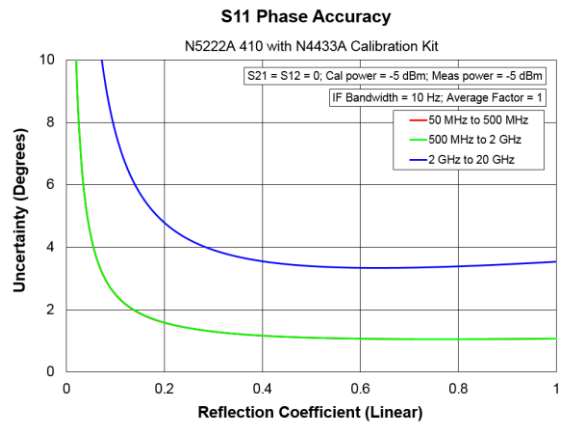
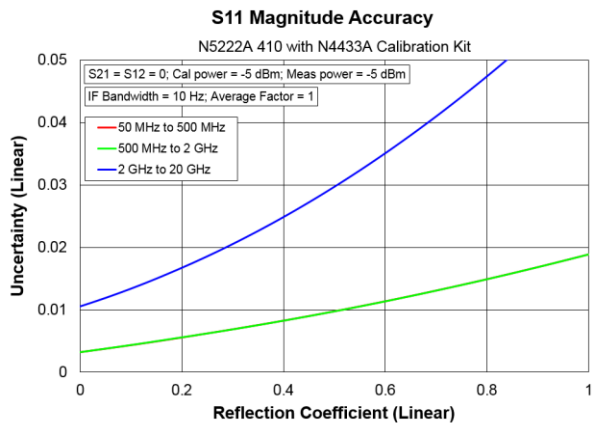

Uncorrected System Performance

Specifications apply to following conditions:

- Over environmental temperature of 25 °C ±5 °C, with less than 1°C variation from the calibration temperature.
- Cable loss not included in Transmission Tracking.
- Crosstalk measurement conditions: normalized to a thru, measured with shorts on all ports, 10 Hz IF bandwidth, averaging factor of 8, alternate mode, source power set to the specified maximum power.

Table 3a. Error Terms (dB), All Ports, Option 210, 410 - Specifications

Description	Directivity	Source Match	Load Match	Transmission Tracking	Reflection Tracking	Crosstalk
10 MHz to 50 MHz	16	31	24	--	--	--
50 MHz to 500 MHz	24	28	26	--	--	--
500 MHz to 3.2 GHz	24	25	24	--	--	--
3.2 GHz to 8 GHz	23	23	21	--	--	--
8 GHz to 10 GHz	23	18	17	--	--	--
10 GHz to 13.5 GHz	16	17	16	--	--	--
13.5 GHz to 16 GHz	16	17	15	--	--	--
16 GHz to 20 GHz	16	15	14	--	--	--
20 GHz to 24 GHz	16	12	12	--	--	--
24 GHz to 26.5 GHz	16	10	10	--	--	--

Table 3b. Error Terms (dB), All Ports, Option 210, 410 – Typical

Description	Directivity	Source Match	Load Match	Transmission Tracking	Reflection Tracking	Crosstalk
10 MHz to 50 MHz	23	37	28	+/- 1.5	+/- 1.5	-84
50 MHz to 100 MHz	29	33	32	+/- 1.5	+/- 1.5	-90
100 MHz to 500 MHz	29	33	32	+/- 1.5	+/- 1.5	-110
500 MHz to 3.2 GHz	31	30	29	+/- 1.5	+/- 1.5	-120
3.2 GHz to 8 GHz	25	27	24	+/- 1.5	+/- 1.5	-122
8 GHz to 10 GHz	25	23	22	+/- 1.5	+/- 1.5	-122
10 GHz to 13.5 GHz	21	22	21	+/- 1.5	+/- 1.5	-122
13.5 GHz to 16 GHz	20	21	20	+/- 1.5	+/- 1.5	-122
16 GHz to 20 GHz	20	19	18	+/- 1.5	+/- 1.5	-122
20 GHz to 24 GHz	19	17	17	+/- 1.5	+/- 1.5	-117
24 GHz to 26.5 GHz	20	15	15	+/- 1.5	+/- 1.5	-114

Test Port Output

See Block diagrams on page 39.

Table 4. Frequency Information, Option 210, 410

Description	Specification	Typical
N5221B Frequency Range	10 MHz to 13.5 GHz	--
N5222B Frequency Range	10 MHz to 26.5 GHz	--
Frequency Resolution	1 Hz	--
Frequency Accuracy	+/- 1 ppm	--
Frequency Stability	--	+/-0.05 ppm, -10° to 70° C ¹ +/-0.1 ppm/yr maximum ²

¹ Assumes no variation in time.

² Assumes no variation in temperature.

Table 5. Maximum Leveled Power (dBm), Option 210, 410

Description	Specification		Typical	
	Port 1, Port 3	Port 2, Port 4	Port 1, Port 3	Port 2, Port 4
10 MHz to 50 MHz	6	6	14	11
50 MHz to 500 MHz	7	7	14	12
500 MHz to 1 GHz	7	7	14	14
1 GHz to 3.2 GHz	7	7	13	14
3.2 GHz to 10 GHz	7	7	16	15
10 GHz to 13.5 GHz	7	7	16	13
13.5 GHz to 16 GHz	7	7	14	12
16 GHz to 20 GHz	7	6	14	10
20 GHz to 24 GHz	7	4	12	8
24 GHz to 26.5 GHz	1	-1	8	5

Table 6. Power Level Accuracy (dB), Option 210, 410

Description	Specification	Typical
10 MHz to 50 MHz	+/- 1.5	+/- 0.5
50 MHz to 500 MHz	+/- 1.0	+/- 0.2
500 MHz to 3.2 GHz	+/- 1.0	+/- 0.1
3.2 GHz to 10 GHz	+/- 1.0	+/- 0.2
10 GHz to 13.5 GHz	+/- 1.2	+/- 0.2
13.5 GHz to 18 GHz	+/- 2.0	+/- 0.3
18 GHz to 26.5 GHz	+/- 2.5	+/- 0.4

Table 7a. Power Level Linearity (dB)

Option 210, 410 - Specification

Description	Port 1 or 3 ¹ -25dBm ≤ P < -20dBm	Port 1 or 3 ¹ -20dBm ≤ P < -15dBm	Port 1 or 3 ¹ P ≥ -15dBm
10 MHz to 50 MHz	+/-2.0	+/-1.5	+/-1.5
50 MHz to 26.5 GHz	+/-1.5	+/-1.5	+/-1.5

¹ Either port can be used as the source port.

Table 7b. Power Level Linearity (dB)

Option 210, 410 - Specification

Description	Port 2 or 4 ¹		Port 2 or 4 ¹ P ≥ -15dBm
	-25dBm ≤ P < -20dBm	-20dBm ≤ P < -15dBm	
10 MHz to 50 MHz	+/-2.5	+/-1.5	+/-1.5
50 MHz to 500 MHz	+/-2.0	+/-1.5	+/-1.5
500 MHz to 26.5 GHz	+/-1.5	+/-1.5	+/-1.5

¹ Either port can be used as the source port.

Table 8. Power Sweep Range (dB), Option 210, 410

Description	Specification		Typical	
	Port 1, Port 3	Port 2, Port 4	Port 1, Port 3	Port 2, Port 4
10 MHz to 50 MHz	31	31	41	38
50 MHz to 500 MHz	32	32	41	39
500 MHz to 1 GHz	32	32	41	41
1 GHz to 3.2 GHz	32	32	40	41
3.2 GHz to 10 GHz	32	32	43	42
10 GHz to 13.5 GHz	32	32	43	40
13.5 GHz to 16 GHz	32	32	41	39
16 GHz to 20 GHz	32	31	41	37
20 GHz to 24 GHz	32	29	39	35
24 GHz to 26.5 GHz	26	24	35	32

Table 9. Nominal (Preset) Power (dBm)

Description	Option 210, 410
Preset Power	-5

Table 10. Power Resolution and Maximum/Minimum Settable Power

Option 210, 410

Description	Specification (dB)	Typical (dBm)
Power Resolution	0.01	--
Maximum Settable Power	--	30
Minimum Settable Power	--	-30

Table 11. 2nd and 3rd Harmonics at Max Specified Power (dBc)

Option 210, 410

Listed frequency is harmonic frequency; test at max specified power

Description	Typical
20 MHz to 4 GHz	-15
4 GHz to 24 GHz	-19
24 GHz to 26.5 GHz	-21

Table 12. Non-Harmonic Spurs at Nominal Power (dBc),

Option 210, 410 - Typical

Description	Based on 8kHz offset Frac-N	Based on 100kHz offset Frac-N
10 MHz to 500 MHz	-50	-50
500 MHz to 2 GHz	-60	-42
2 GHz to 4 GHz	-57	-45
4 GHz to 8 GHz	-51	-39
8 GHz to 16 GHz	-45	-33
16 GHz to 26.5 GHz	-39	-27

Table 13. Phase Noise (dBc/Hz), Option 210, 410 – Typical

Description	1 kHz Offset	10 kHz Offset	100 kHz Offset	1 MHz Offset
10 MHz to 50 MHz	-100	-95	-95	-120
50 MHz to 1 GHz	-107	-117	-112	-127
1 GHz to 2 GHz	-101	-111	-106	-121
2 GHz to 4 GHz	-95	-105	-100	-115
4 GHz to 8 GHz	-89	-99	-94	-109
8 GHz to 16 GHz	-83	-93	-88	-103
16 GHz to 26.5 GHz	-77	-87	-82	-97

Test Port Input

Table 14. Test Port Noise Floor (dBm) @ 10 Hz IFBW, Option 210, 410

Total average (rms) noise power calculated as the mean value of a linear magnitude trace expressed in dBm. May typically be degraded at particular frequencies below 500 MHz due to spurious receiver residuals.

Description	Specification	Typical
10 MHz to 50 MHz	-82	-88
50 MHz to 100 MHz	-95	-103
100 MHz to 500 MHz	-105	-110
500 MHz to 2 GHz	-114	-118
2 GHz to 13.5 GHz	-114	-119
13.5 GHz to 20 GHz	-114	-120
20 GHz to 24 GHz	-111	-118
24 GHz to 26.5 GHz	-107	-116

Table 15. 0.1 dB Receiver Compression at Test Port (dBm)

Option 210, 410

Description	Typical
10 MHz to 100 MHz	15
100 MHz to 20 GHz	12
20 GHz to 26.5 GHz	10

Table 16. Receiver Compression at Test Port Power - Specification

Description	Test Port Power (dBm)	Receiver Compression	
	Option 210, 410	Magnitude (dB)	Phase (degrees)
10 MHz to 500 MHz ¹	--	--	--
500 MHz to 3.2 GHz	8	0.12	0.65
3.2 GHz to 10 GHz	8	0.12	0.85
10 GHz to 13.5 GHz	8	0.15	1.40
13.5 GHz to 16 GHz	8	0.18	1.45
16 GHz to 20 GHz	8	0.12	0.70
20 GHz to 24 GHz	8	0.24	1.70
24 GHz to 26.5 GHz	8	0.42	2.50

¹Test port receiver compression at specified input levels below 500 MHz due to coupler roll off in this frequency range.

Table 17. Trace Noise Magnitude (dB rms)

Ratioed measurement, nominal power at test port.

Description	Specification	Typical		
	1 kHz IFBW	1 kHz IFBW	100 kHz IFBW	600 kHz IFBW
10 MHz to 100 MHz	0.007	0.0036	0.053	0.103
100 MHz to 13.5 GHz	0.002	0.0005	0.004	0.010
13.5 GHz to 16 GHz	0.002	0.0003	0.003	0.007
16 GHz to 22.5 GHz	0.002	0.0005	0.003	0.007
22.5 GHz to 24 GHz	0.003	0.0008	0.004	0.011
24 GHz to 26.5 GHz	0.005	0.0012	0.007	0.017

Table 18. Trace Noise Phase (deg rms)

Ratioed measurement, nominal power at test port.

Description	Specification	Typical		
		1 kHz IFBW	100 kHz IFBW	600 kHz IFBW
10 MHz to 100 MHz	0.051	0.0237	0.341	0.663
100 MHz to 13.5 GHz	0.015	0.0045	0.027	0.067
13.5 GHz to 16 GHz	0.042	0.0045	0.019	0.042
16 GHz to 22.5 GHz	0.042	0.0075	0.024	0.050
22.5 GHz to 24 GHz	0.054	0.0080	0.031	0.073
24 GHz to 26.5 GHz	0.054	0.0128	0.049	0.118

Table 19. Reference Level Magnitude, Option 210, 410 - Specification

Description	Magnitude (dB)	Phase (degrees)
Range	+/- 500	+/- 500
Resolution	0.001	0.01

Table 20. Stability vs. Temperature, Option 210, 410 - Typical

Description	Magnitude (dB/°C)	Phase (°/°C)
10 MHz to 50 MHz	0.010	0.180
50 MHz to 500 MHz	0.010	0.060
500 MHz to 3.2 GHz	0.010	0.080
3.2 GHz to 10 GHz	0.020	0.130
10 GHz to 13.5 GHz	0.020	0.160
13.5 GHz to 16 GHz	0.020	0.300
16 GHz to 20 GHz	0.020	0.400
20 GHz to 24 GHz	0.030	0.500
24 GHz to 26.5 GHz	0.030	0.560

Table 21. Stability vs. Time, Option 210, 410 – Specification

The specifications below are observations of the maximum drift performance over +/- 0.5 °C and a period of 24 hours subsequent to a 48 hour warm up period, with ideal load for reflections and ideal thru for transmission measurements.

Description	Magnitude (dB/24 hours)		
	S11, S22, S33, S44	S21, S12, S43, S34	S31, S13, S41, S14, S42, S24, S32, S23
10 MHz to 12 MHz ¹	-52	0.013	0.018
12 MHz to 500 MHz ¹	-60	0.013	0.018
500 MHz to 3.2 GHz	-65	0.010	0.014
3.2 GHz to 10 GHz	-65	0.016	0.023
10 GHz to 13.5 GHz	-65	0.020	0.028
13.5 GHz to 16 GHz	-65	0.025	0.035
16 GHz to 20 GHz	-65	0.026	0.037
20 GHz to 24 GHz	-65	0.029	0.041
24 GHz to 26.5 GHz	-65	0.032	0.045

¹ Performance may be degraded at frequencies below 500 MHz due to spurious receiver residuals.

Table 22. Damage Input Level

Description	Option 200, 201, 219, 400, 401, 419	Option 217, 417
RF, DC	30 dBm, 40 V	30 dBm, 7 V

Dynamic Accuracy

Dynamic accuracy is verified with the following measurements:

Compression over frequency

IF linearity at a single frequency of 1.998765GHz using a reference level of -20 dBm for an input power range of 0 to -60 dBm. For values below -60 dBm, refer to [VNA Receiver Dynamic Accuracy Specifications and Uncertainties](#).

Table 23. N5221B and N5222B Dynamic Accuracy

N5221B/22B Dynamic Accuracy, 50 MHz - Specification

Magnitude

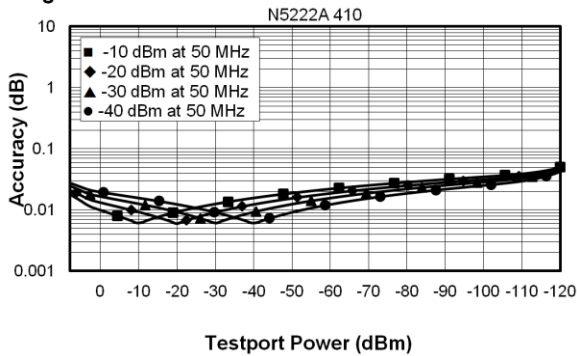

Phase

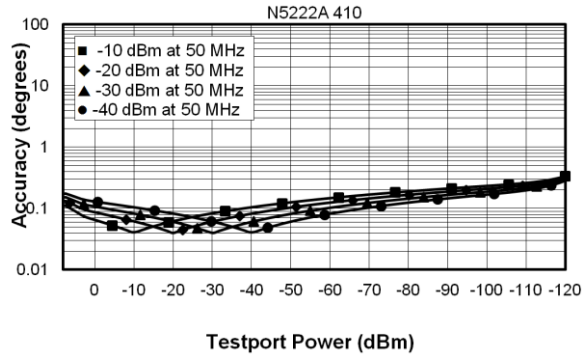

N5221B/22B Dynamic Accuracy, 500 MHz - Specification

Magnitude

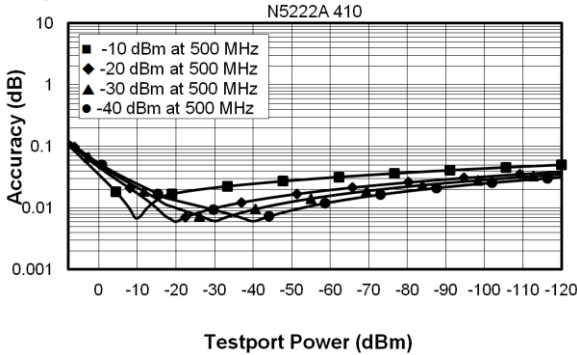

Phase

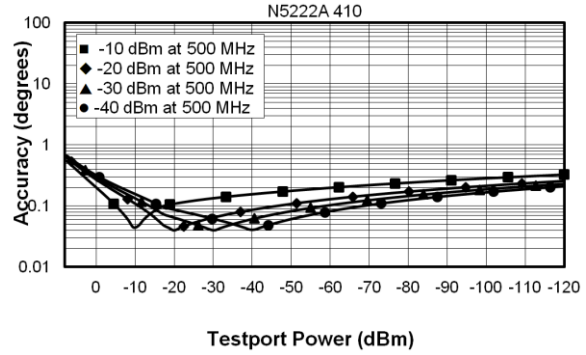

N5221B/22B Dynamic Accuracy, 1 GHz - Specification

Magnitude

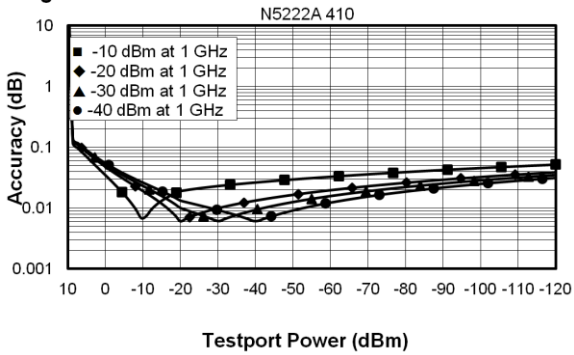

Phase

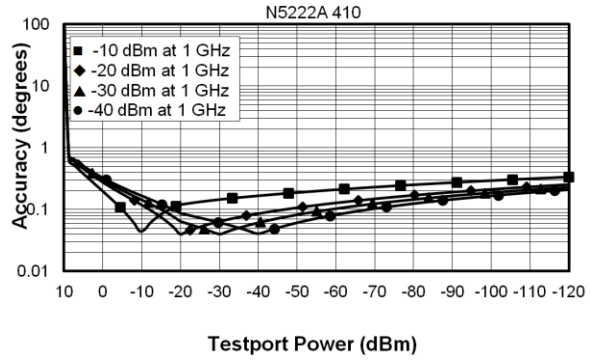

N5221B/22B Dynamic Accuracy, 2 GHz - Specification

Magnitude

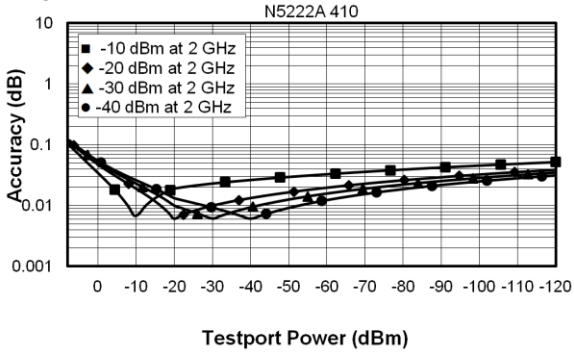

Phase

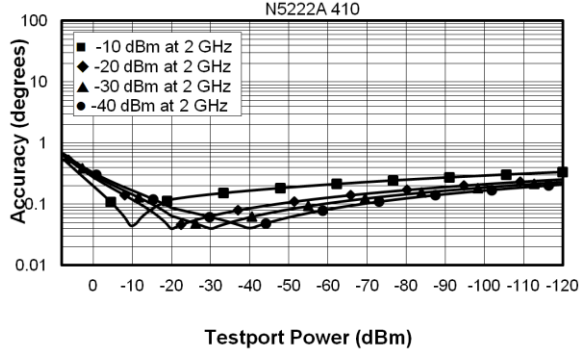

N5221B/22B Dynamic Accuracy, 20 GHz - Specification

Magnitude

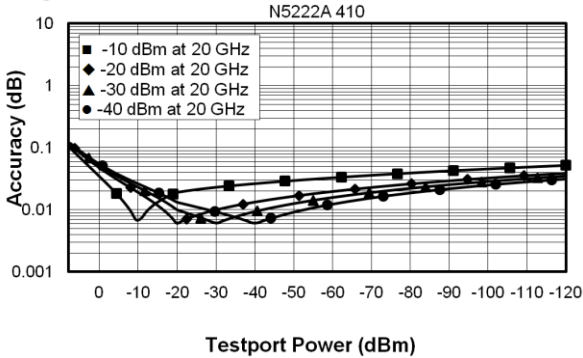

Phase

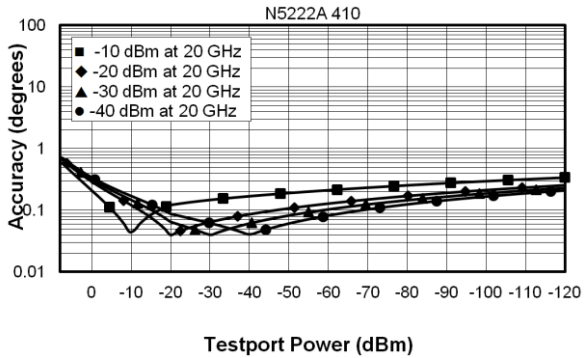

N5221B/22B Dynamic Accuracy, 26.5 GHz - Specification

Magnitude

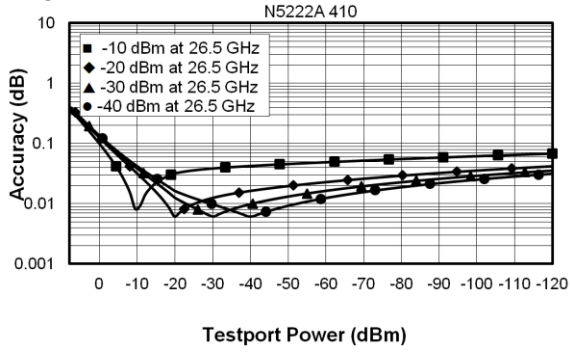

Phase

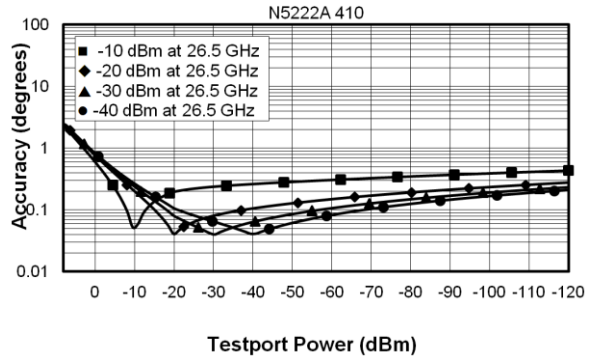

Table 24. Group Delay - Typical

Group delay is computed by measuring the phase change within a specified frequency step (determined by the frequency span and the number of points per sweep). In general, the following formula can be used to determine the accuracy, in seconds, of specific group delay measurement:

$$\pm \text{Phase Accuracy (deg)} / [360 \times \text{Aperture (Hz)}]$$

Depending on the aperture and device length, the phase accuracy used is either incremental phase accuracy or worst-case phase accuracy

Description	Typical Performance
Aperture (selectable)	(frequency span)/(number of points -1)
Maximum Aperture	20% of frequency span
Range	0.5 x (1/minimum aperture)
Maximum Delay	Limited to measuring no more than 180° of phase change within the minimum aperture.)

The following graphs show characteristic group delay accuracy with full 2-port calibration and a 10 Hz IF bandwidth. Insertion loss is assumed to be < 2 dB and electrical length to be ten meters.

For any S_{ij} Group Delay measurement, $S_{ii} = 0$, $S_{ij} = 1$, $S_{ji} = 0$, $S_{kl} = 0$ for all $kl \neq ij$

Group Delay (Typical)

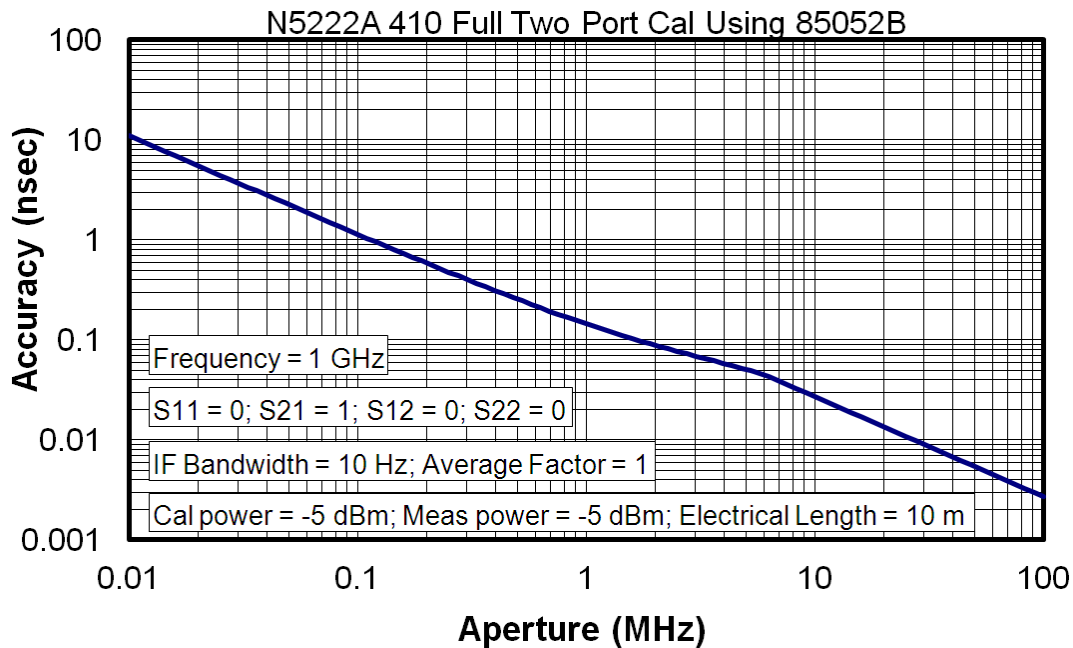

General Information

- [Miscellaneous Information](#)
- [Front Panel](#)
- [Rear Panel](#)
- [Environment and Dimensions](#)

Table 25. Miscellaneous Information

Description	Supplemental Information
System IF Bandwidth Range	1 Hz to 15 MHz, nominal
CPU	For the latest information on CPUs and associated hard drives, visit: http://na.support.keysight.com/pna/hdnumbers.html
LXI	Class C

Table 26. Front Panel Information, Option 210, 410

Description	Typical Performance
RF Connectors	
Type	3.5 mm (male), 50 ohm, (nominal)
Center Pin Recession	0.002 in. (characteristic)
USB 2.0 Ports - Master (4 ports)	
Standard	Compatible with USB 2.0
Connector	USB Type-A female
Display	
Size	31 cm (12.1 in) diagonal color active matrix LCD; 1280 (horizontal) X 800 (vertical) resolution
Refresh Rate	Vertical 60 Hz; Horizontal 49.31 kHz
Pixels	Any of the following would cause a display to be considered faulty: <ul style="list-style-type: none"> • A complete row or column consists of “stuck” or “dark” pixels. • More than six “stuck on” pixels (but not more than three green) or more than 0.002% of the total pixels are within the LCD specifications. • More than twelve “dark” pixels (but no more than seven of the same color) or more than 0.004% of the total pixels are within the LCD specifications. • Two or more consecutive “stuck on” pixels or three or more consecutive “dark” pixel (but no more than one set of two consecutive dark pixels). • “Stuck on” pixels or more than two “dark” pixels less than 6.5 mm apart (excluding consecutive pixels).

Table 26. (Continued) Front Panel Information, Option 210, 410

Description	Typical Performance
Display Range	
Magnitude	+/-2500 dB (at 500 dB/div), max
Phase	+/-2500° (at 500 dB/div), max
Polar	10 pUnits, min 10,000 Units, max
Display Resolution	
Magnitude	0.001 dB/div, min
Phase	0.01°/div, min
Marker Resolution	
Magnitude	0.001 dB, min
Phase	0.01°, min
Polar	10 pUnit, min

Table 27. Rear Panel Information, Option 210, 410

Description	Typical Performance
10 MHz Reference In	
Connector	BNC, female
Input Frequency	10 MHz ± 10 ppm
Input Level	-15 dBm to +20 dBm
Input Impedance	200 Ω, nom.
10 MHz Reference Out	
Connector	BNC, female
Output Frequency	10 MHz ± 1 ppm
Signal Type	Sine Wave
Output Level	+10 dBm ± 4 dB into 50 Ω
Output Impedance	50 Ω, nominal
Harmonics	<-40 dBc, typical

Table 27. (Continued) Rear Panel Information, Option 210, 410

Description	Typical Performance
External IF Inputs	
Function	Allows use of external IF signals from remote mixers, bypassing the PNA's first converters
Connectors	SMA (female); A, B, C, D, R (4-port); A, B, R1, R2 (2-port)
Input Frequency	
Normal IF path	RF < 53 MHz: IF = 826.446 KHz RF >= 53 MHz: IF = 7.438 MHz
Narrowband IF path	IF = 10.70 MHz
Input Impedance	50 Ω
RF Damage Level	+23 dBm
DC Damage Level	5.5 VDC
0.1 dB Compression Point	
Normal IF path	-9.0 dBm at 7.438 MHz
Narrowband IF path	-17 dBm at 10.70 MHz
Pulse Inputs (IF Gates)	
Function	Internal receiver gates used for point-in-pulse and pulse-profile measurements
Connectors	15-pin mini D-sub
Input Impedance	1 K Ohm
Minimum Pulse Width, Source Modulators	33 ns
Minimum Pulse Width, Receiver Gates	20 ns
DC Damage Level	5.5 VDC
Drive Voltage	0 V (off), +3.3 V (on), nominal
RF Pulse Modulator Input (Source Modulator)	
On/Off Ratio	
10 MHz to 3.2 GHz	-64
3.2 GHz to 26.5 GHz	-80
Pulse Period	
Minimum	33 ns
Maximum	70 s

Table 27. (Continued) Rear Panel Information, Option 210, 410

Description	Typical Performance	
Pulse Outputs		
Voltage (TTL)	High: 3.3V to 3.5V Low: <1V	
Impedance	50 Ohm	
External Test Set Driver		
Function	Used for driving remote mixers	
Connections	3.5 mm (female)	
RF Output Frequency Range	3.2 GHz to 19 GHz	
LO Output Frequency Range	1.76 GHz to 26.5 GHz	
Rear Panel LO Power¹		
	Upper Limit, Typical (dBm)	Lower Limit, Typical (dBm)
1.7 GHz to 16 GHz	0	-10
16 GHz to 21 GHz	4	-6
21 GHz to 26.5 GHz	6	-4
Rear Panel RF Power		
	Upper Limit, Typical (dBm)	Lower Limit, Typical (dBm)
3.2 GHz to 19 GHz	-3	-8
Devices Supported		
	Resolutions	
Flat Panel (TFT)	1024 X 768, 800 X 600, 640 X 480	
Flat Panel (DSTN)	800 X 600, 640 X 480	
CRT Monitor	1280 X 1024, 1024 X 768, 800 X 600, 640 X 480	

Simultaneous operation of the internal and external displays is allowed, but with 640 X 480 resolution only. If you change resolution, you can only view the external display (internal display will "white out").

¹ LO output available in full analyzer's frequency range. The power is tested only from 3.2 GHz to 26.5 GHz.

Table 27. (Continued) Rear Panel Information, Option 210, 410

Description	Typical Performance
Trigger Inputs/Outputs	BNC(f), TTL/CMOS compatible
Test Set IO	25-pin D-Sub connector, available for external test set control
Power IO	9-pin D-Sub, female; analog and digital IO
Handler IO	36-pin parallel I/O port; all input/output signals are default set to negative logic; can be reset to positive logic via GPIB command
Pulse I/O	15-pin D connector provides access to Pulse Modulators and Generators
GPIB	Two ports - dedicated controller and dedicated talker/listener. 24-pin D-sub (Type D-24), female; compatible with IEEE-488
PCIe	Cabled PCIe x4 connector is a 4-lane slot (not currently used)
USB Ports	Two SuperSpeed USB ports (900 mA each), one USB port below LAN connector, and one USB device port. There are also four USB ports (500 mA each) on the front panel. The total current limit for all rear panel USB ports is 2.3 amps. The total current limit for all front panel USB ports is 2 amps.
LAN	10/100/1000 BaseT Ethernet, 8-pin configuration; auto selects between the data rates
VGA Video Output	15-pin mini D-Sub; Drives VGA compatible monitors
Mini DisplayPort	Miniature DisplayPort connector for connection to external displays
Line Power	
Frequency, Voltage	50/60/400 Hz for 100 to 120 VAC 50/60 Hz for 220 to 240 VAC
	Power supply is auto switching
Max	450 watts

Table 28. Analyzer Dimensions and Weight

All models are shipped with handles.

Cabinet Dimensions	Metric (mm)	Imperial (inches)
Height		
Without bottom feet: ¹ EIA RU = 6	266.1	10.5
With bottom feet	279.1	11.0
Width		
Without handles or rack-mount flanges	425.6	16.8
With handles, without rack-mount flanges	458.7	18.1
With handles and rack-mount flanges	482.9	19.0
Depth		
Without front and rear panel hardware	533.0	21.0
With front and rear panel hardware, handles	578.0	22.7

¹Electronics Industry Association rack units. 1 RU = 1.75 in.

See detailed PNA dimension drawings at: <http://na.support.keysight.com/pna/PNADimensions.pdf>

Weight (nominal)	Net	Shipping
2-port models (Option 200, 201, 217 or 219)	27 kg (60 lb)	43 kg (95 lb)
4-port models (Option 400, 401, 417 or 419)	36.7 kg (81 lb)	51 kg (112 lb)

Regulatory and Environmental Information

For Regulatory and Environmental information, refer to the PNA Series Installation and Quick Start Guide, located online at: <http://literature.cdn.keysight.com/litweb/pdf/E8356-90001.pdf>

Measurement Throughput Summary

- Typical Cycle Time for Measurement Completion
- Cycle Time vs. IF Bandwidth
- Cycle Time vs. Number of Points
- Data Transfer Time

Cycle time Includes sweep time, retrace time and band-crossing time. Analyzer display turned off with DISPLAY:ENABLE OFF. Add 21 ms for display on. Data for one trace (S₁₁) measurement.

Table 29a. Typical Cycle Time (ms) for Measurement Completion, All Models and Options

Sweep Range	IF Bandwidth		Number of Points				
			201	401	1601	16001	32001
9 GHz to 10 GHz	600 kHz	Uncorrected	6.3	6.3	10.9	68	132
		2-Port cal	18.8	20.3	30	145	275
	10 kHz	Uncorrected	29.7	54.7	205	2000	4000
		2-Port cal	67	117	417	4031	8047
	1 kHz	Uncorrected	227	445	1742	17031	33844
		2-Port cal	462	900	3500	34102	67734
10 GHz to 20 GHz	600 kHz	Uncorrected	18.8	18.8	23	70	133
		2-Port cal	45.3	46.9	55	180	313
	10 kHz	Uncorrected	69	127	270	2009	4009
		2-Port cal	145	263	548	4030	8055
	1 kHz	Uncorrected	234	458	1781	17383	34531
		2-Port cal	477	922	3578	34789	69109

Table 29b. N5221B Typical Cycle Time (ms) for Full-Span Measurement Completion

10 MHz to 13.5 GHz		Number of Points				
IF Bandwidth		201	401	1601	16001	32001
600 kHz	Uncorrected	6.9	7.2	11.9	69	132
	2-Port cal	22.2	23.1	32.2	148	275
10 kHz	Uncorrected	59	61	205	2004	4003
	2-Port cal	126	130	418	4019	8020
1 kHz	Uncorrected	204	402	1593	15877	31751
	2-Port cal	416	813	3194	31766	63539

Table 29c. N5222B Typical Cycle Time (ms) for Full-Span Measurement Completion

10 MHz to 26.5 GHz		Number of Points				
IF Bandwidth		201	401	1601	16001	32001
600 kHz	Uncorrected	43	50	68	141	198
	2-Port cal	93	107	141	284	405
10 kHz	Uncorrected	80	142	480	2184	4125
	2-Port cal	168	291	964	4378	8297
1 kHz	Uncorrected	245	472	1809	17508	34773
	2-Port cal	498	950	3622	35047	69609

Table 30. Cycle Time vs. IF Bandwidth - Typical

Applies to the Preset condition (201 points, correction off) except for the following changes:

- CF = 10 GHz
- Span = 100 MHz
- Display off (add 21 ms for display on)

Cycle time includes sweep and retrace time.

Description		N5221B/22B
IF Bandwidth (Hz)	Cycle Time (ms)	Trace Noise Magnitude (dB rms)
600,000	5.6	0.0045
100,000	6.9	0.0018
30,000	10	0.0011
10,000	26.7	0.0006
3,000	72	0.0004
1,000	223	0.0003
300	641	0.0002
100	1825	0.0002
30	5984	0.0002
10	17836	0.0002
3	59281	0.0002

Table 31. Cycle Time vs. Number of Points - Typical

Applies to the Preset condition (correction off) except for the following changes:

- CF = 10 GHz
- Span = 100 MHz
- Display off (add 21 ms for display on)

Cycle time includes sweep and retrace time.

Description	IF Bandwidth (Hz)			
	1,000	10,000	30,000	600,000
3	7.5	5.9	5.9	5.9
11	15.6	6.6	5.9	5.9
51	60	10.6	5.9	5.9
101	114	16.9	7.2	6.3
201	223	29.4	9.7	6.3
401	437	54.7	15	6.9
801	862	105	25.3	7.8
1,601	1706	203	45.9	11
6,401	6728	803	169	30
16,001	16669	2003	416	68
32,001	33106	4003	828	130

Table 32. Data Transfer Time (ms) – Typical

Measured with the analyzer display off.

Values will increase slightly if the analyzer display is on.

Description	Number of Points				
	201	401	1601	16,001	32,001
SCPI over GPIB (Program executed on external PC ²)					
32-bit floating point	4.6	9.3	38	352	720
64-bit floating point	9.4	18.8	73.4	730	1455
ASCII	36.7	72.5	288	2882	5762
SCPI over SICL/LAN or TCP/IP Socket¹ (Program executed in the analyzer)					
32-bit floating point	<1	<1	<1	1.2	2.4
64-bit floating point	<1	<1	<1	2.3	4.6
ASCII	2.1	4	15	148	295
COM¹ (Program executed in the analyzer)					
32-bit floating point	<1	<1	<1	<1	<1
Variant type	<1	<1	1.4	12.4	25.5
DCOM over LAN¹ (Program executed on external PC)					
32-bit floating point	<1	<1	<1	2.3	4.4
Variant type	<1	1.6	5.3	52	105.5

¹ Values are for real and imaginary pairs, with the analyzer display off, using Gigabit Ethernet.

NOTE Specifications for Recall & Sweep Speed are not provided for the N522xB analyzers.

Test Set Block Diagrams

NOTE For best readability, use a color printer for printing the following graphics.

Legend

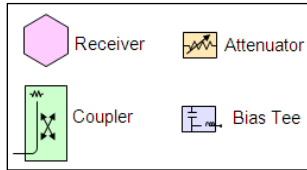

N5221B and N5222B Option 210 (2-port metrology configuration)

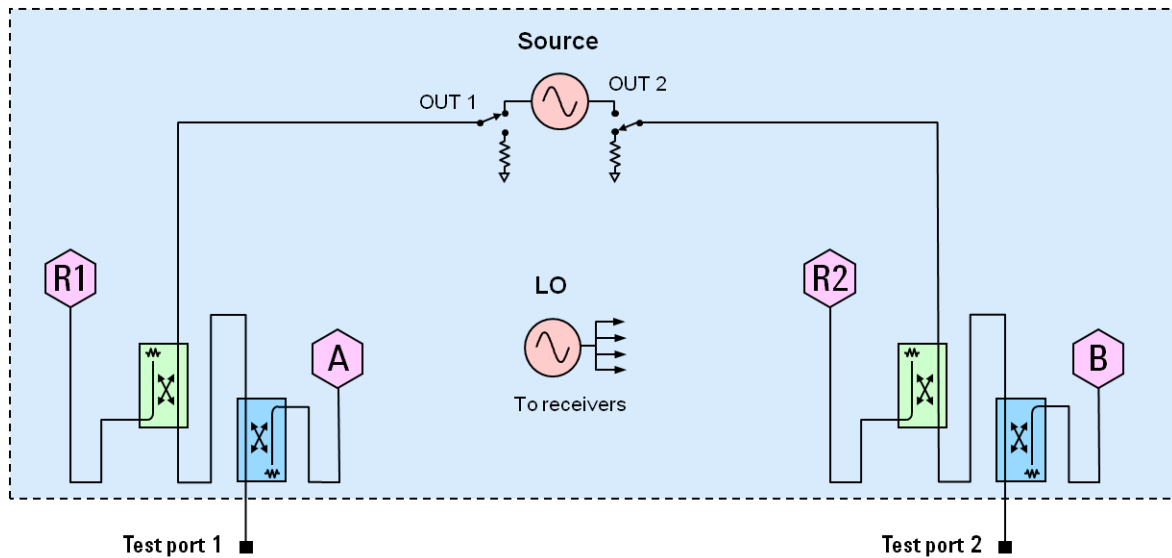

N5221B and N5222B Option 410 (4-port metrology configuration)

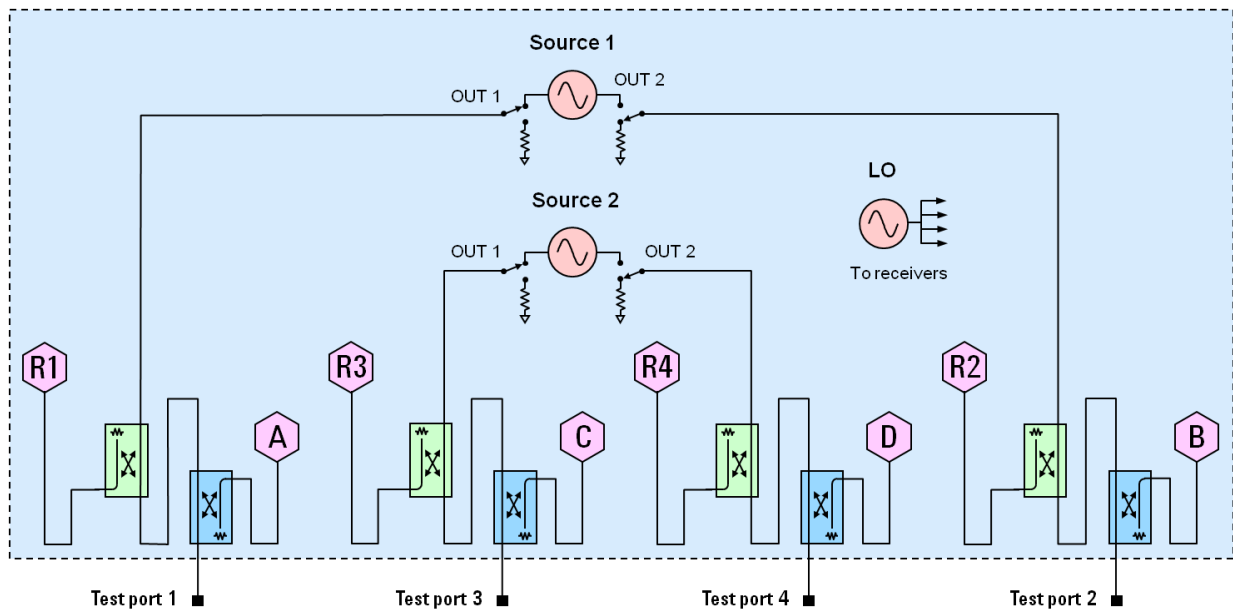

Receiver Block Diagram

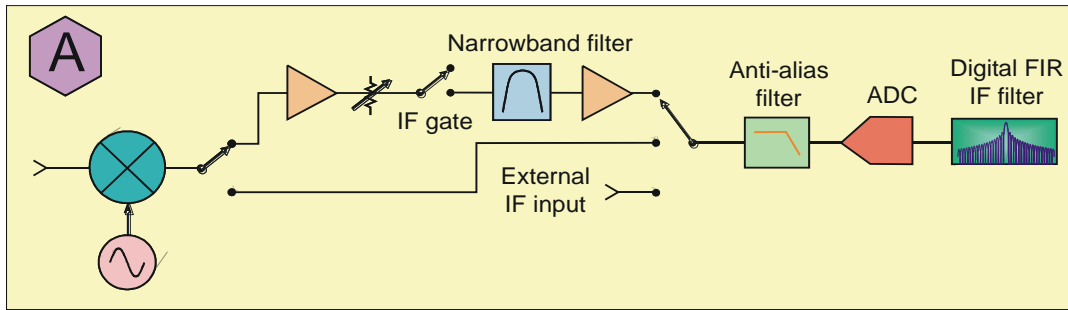



This information is subject to change without notice.
© Keysight Technologies 2017
Print Date: May 1, 2017



N5221-90004

www.keysight.com