

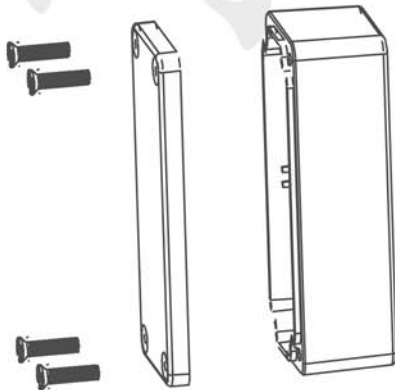

长河机箱  
Changhe Enclosures

<http://www.enclosures.com.cn>

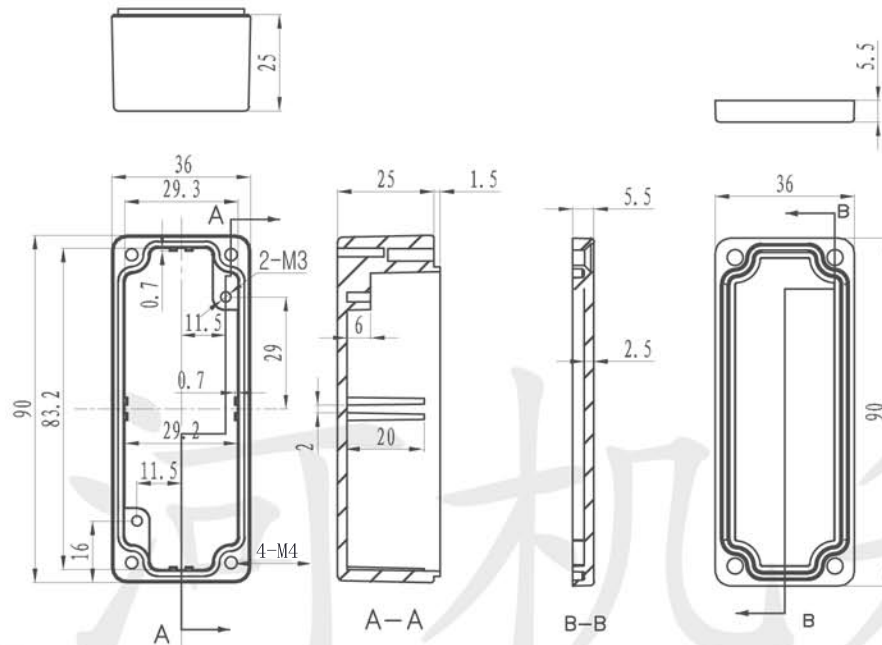

制图 Drawing	审核 Auditing	批准 Confirm	产品名称 Product Name	铝合金防水盒 Sealed aluminium enclosure	材料 Material	Die-Cast aluminium
			产品编号 Product Code	11A-19	视图 Project View	(m m)
					图纸比例 Drawing Scale	
共 张 第 张				宁波大洋壳体有限公司 Ningbo Dayang Enclosures CO.,LTD		

底图总号	
D	
旧底图总号	
日期	签字