



杭州飞华照明电器有限公司

VIVALUX CO.,LTD.

No. 360, West Tianmushan Road, Yuhang Community, Yuhang District, Hangzhou, Zhejiang, China

Specification Sheet of T8-60-9W-C

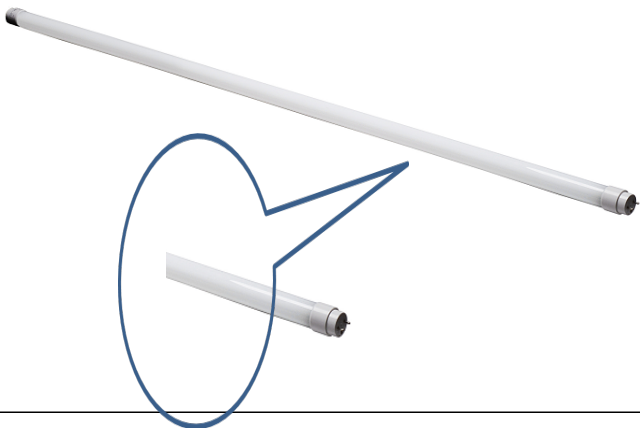
Name :	LED Tube	Product Photo 	
Model :	T8-60-9W-C		
Description			
Performance:	High luminous efficacy LED Working Temperature: -20~+50°C		
Features :	Safety glass.No fault, no breakage Using High Brightness SMD LEDs; Diffused milky cover, soft and uniform light; No ballast, no flicker; Light up immediately; Low power consumption; Easy installation and replacement;		
Application:	Suitable for workshop, hotel, supermarket, school and home lighting.	Brand:	ADDVIVA®
		Standards :	EN62471; EN62560; EN60968;EN55015; EN61547; ROHS

Specifications		Photochromic Parameter						
		Color	Warm White		Neutral White		Cool White	
Power Consumption ±10%	9W	Color Temperature	2700K(2600-2850K)		4000K(3800-4200K)		6500K(6100-6900K)	
LED Qty	48 pcs	Luminous Flux -10%	880lm	810lm	900lm	820lm	980lm	910lm
Rated Voltage	230VAC 50Hz	Light Efficacy	90 lm/W	85 lm/W	95 lm/W	85 lm/W	95 lm/W	90 lm/W
Rated Current	80mA		CRI	>70	>80	>70	>80	>70
Lamp base	G13	Central Light Intensit	170cd	160cd	200cd	170cd	200cd	170cd
Power Factor	>0.5	Viewing Angle	200°					
Lamp body	Aluminum+Glass cover	*Testing Conditions: (Pre-Heat Time : >1 hour; Interior Temperature : 25±1 °C; Humidity: 45~75%)						
Heat-dissipation method	Aluminum Heat-dissipa							
Life time	30000 hours							
Warranty Period	2 years							

Package Information					
Lamp Size	Ø28.5*588mm	Outer Carton Size	660*225*235mm	Qty in 1 Pallet	1400 pcs
Lamp Weight	0.16Kg	Qty in 1 Carton	25 pcs	Qty in 1*20' container	14000 pcs
Inner Box Size	Ø40*640mm	Gross Weight	12Kg	Qty in 1*40' Container	29400 pcs

Dimension: (mm)	Light Distribution Curve:(cd)	Illuminance at a distance (lux)
------------------------	--------------------------------------	--

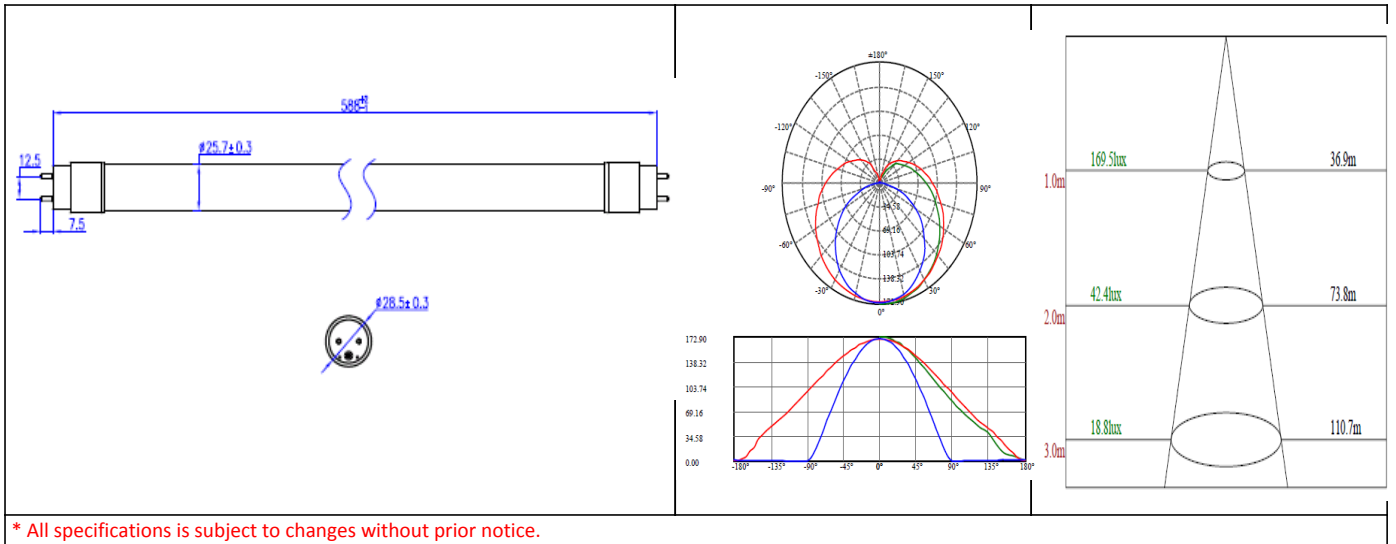

WWW.ADDVIVA.COM



杭州飞华照明电器有限公司

VIVALUX CO.,LTD.

No. 360, West Tianmushan Road, Yuhang Community, Yuhang District, Hangzhou, Zhejiang, China

Specification Sheet of T8-60-9W-C

Light Distribution Curve:(cd)

Illuminance at a distance (lux)

CCT : 2700K
Ra>80

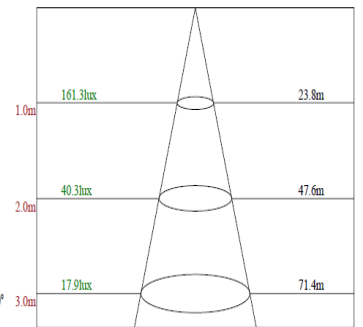
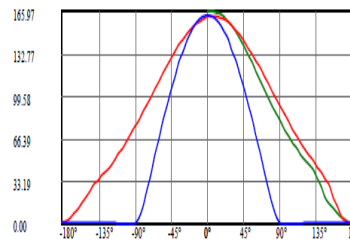
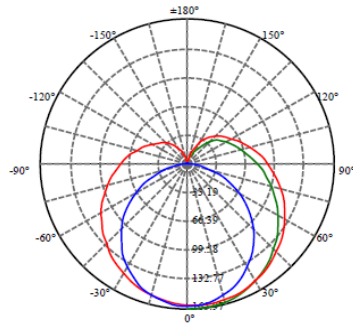

CCT : 4000K
Ra>80

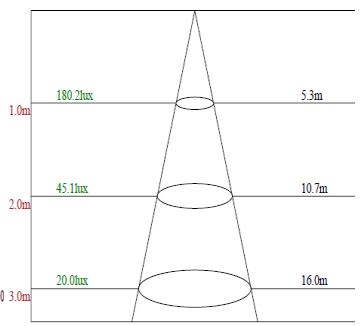
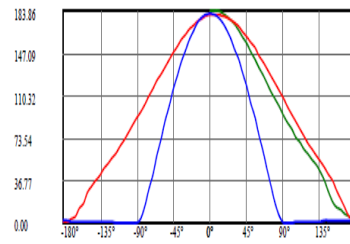
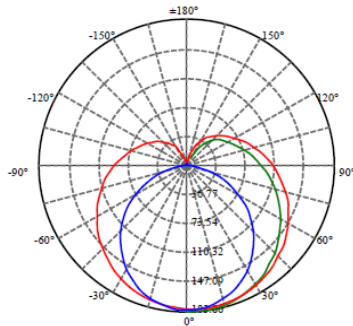

CCT : 6500K
Ra>80

