



RoHS

Specification

规格书

Client Name : _____

客户名称 :

Client P/N : _____

客户品号 :

Product P/N : HL-C3535S14V-LVR15

产品型号 :

Sending Date: _____

送样日期 :

Client approval 客户审核			Hongli approval 鸿利光电审核		
Approval 核准	Audit 确认	Confirmation 制作	Approval 核准	Audit 确认	Confirmation 制作
					杜金晟
<input type="checkbox"/> Qualified 接受		<input type="checkbox"/> Disqualified 不接受		DATE: 日期:	

Address : Xianke 1st Rd, Huadong Town, Huadu Dist., Guangzhou, China

地址 : 广州市花都区花东镇先科一路1号

Tel/电话 : 020-86733333

Fax/传真 : 020-86733883 86733938

Web/网址 : www.honglitronic.com

注:1. 此规格书以中英文方式书写,若有冲突以中文版本为准文本.

2. 此规格书的最终解释权归广州鸿利光电股份有限公司

3. 此规格书的有效期限为两年,自盖章或签字之日起计算,期满时双方可以续签协议,但应采用书面形式



Under Development	●
Mass production	

Deep Ultraviolet LED
P/N: HL-C3535S14V-LVR15



ATTENTION
OBSERVE PRECAUTIONS
FOR HANDLING
ELECTROSTATIC
DISCHARGE
SENSITIVE
DEVICES

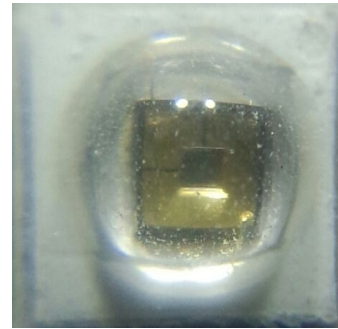

Features 特点

- Dimension 尺寸 : 3.45mm×3.45mm×1.9mm
- Viewing angle 发光角度 : 120°
- RoHS compliant (ROHS标准)
- Anti-vulcanization 抗硫化
- Reflow Solder-able 可回流焊

Applications 应用

- Fluorescent spectroscopy 荧光光谱分析
- Sensors and monitors 传感器和监控器
- Bio-analysis/detection 生物分析/检测
- Phototherapy 光疗
- Disinfection 消毒

Package Dimensions 封装尺寸

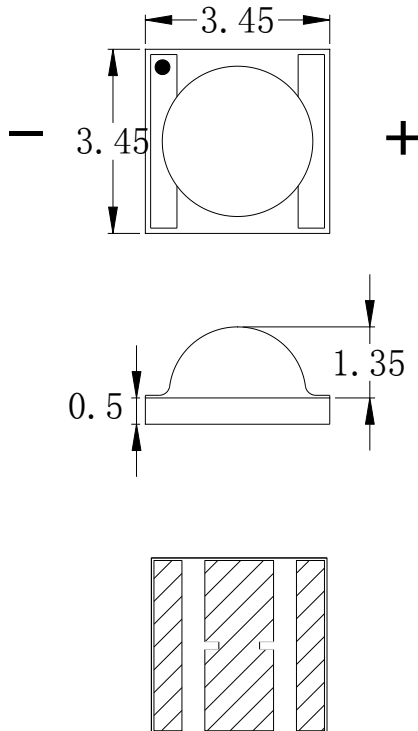

Recommended Soldering 推荐焊接

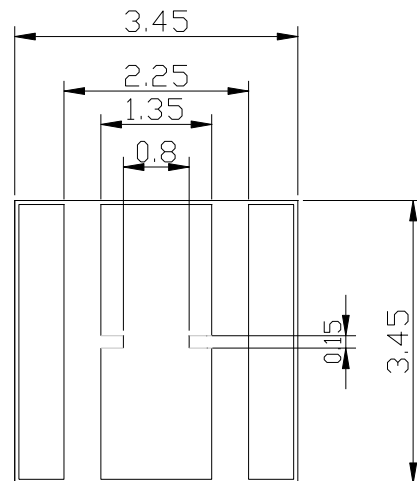

Notes 注意:

- All dimension units are millimeters. 所有尺寸单位均为毫米。
- All dimension tolerance is ± 0.2 mm unless otherwise noted. 所有尺寸误差是 ± 0.2 毫米除非另有说明。

Deep Ultraviolet LED

P/N: HL-C3535S14V-LVR15

Radiation Pattern 辐射模式

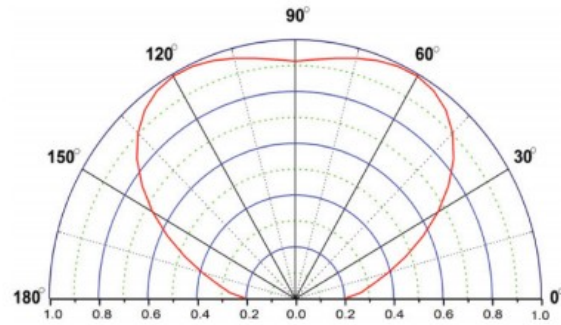

Typical Optical/ Electrical Characteristics @T_a=25°C 典型的光学/电气特性在 Ta=25°C

Parameters 参数	Symbol 符号	Forward Current IF	Min.	Typ.	Max.	Unit 单位
Forward Voltage 正向电压	VF	@20mA	5.5	6	—	V
Optical Power 光功率	P _{out}	@20mA	0.9	1.0		mW
Peak Wavelength 峰值波长	λ _p	@20mA	275	280	285	—
FWHM 半峰宽	—	@20mA	9	10	—	nm
Lifetime 寿命	L(50)	@20mA	650	700	800	Hour

Notes 注:

1. Tolerance of measurement of forward voltage ±0.1V、peak Wavelength ±2.0nm、luminous power ±5%
 测量正向电压误差为 ±0.1、波长误差为 2.0nm、光功率误差为 ±5%。

Absolute Maximum Ratings 绝对最大额定值在 TA=25°C

Parameter 参数	Symbol 符号	Rating Value 值	Units 单位
Input power 输入功率	P _i	0.12	W
Maximum operating current 最大工作电流	I _{Fmax}	20	mA
Junction Temperature 结温	T _j	115	°C
Operating Temperature Range 工作温度	T _{op}	-20°C To +45°C	
Storage Temperature Range 储藏温度	T _{stg}	-40°C To +80°C	
Lead Soldering Temperature* 引线焊接温度	T _{sol}	Max. 350°C for 5sec Max.	

Note:

1. The temperature of Aluminum PCB do not exceed 45°C. 基板温度不超过 45°C。

Deep Ultraviolet LED
P/N: HL-C3535S14V-LVR15

Typical Optical/Electrical Characteristics Curves 典型光学/电性特征曲线
($T_a=25^\circ\text{C}$ Unless Otherwise Noted) ($T_a=25^\circ\text{C}$ 除非另有注释)

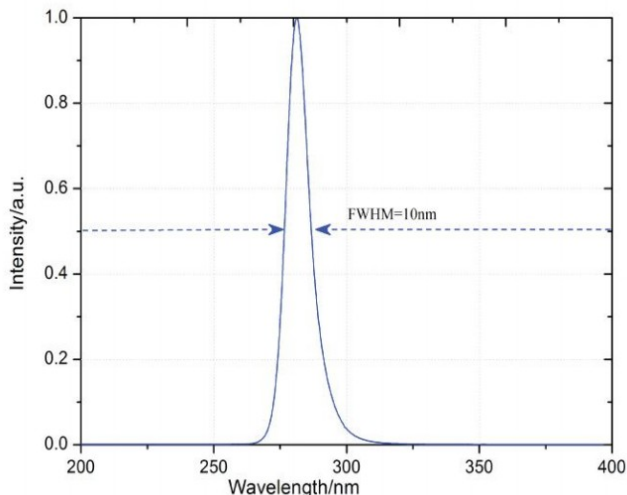

相对光谱分布

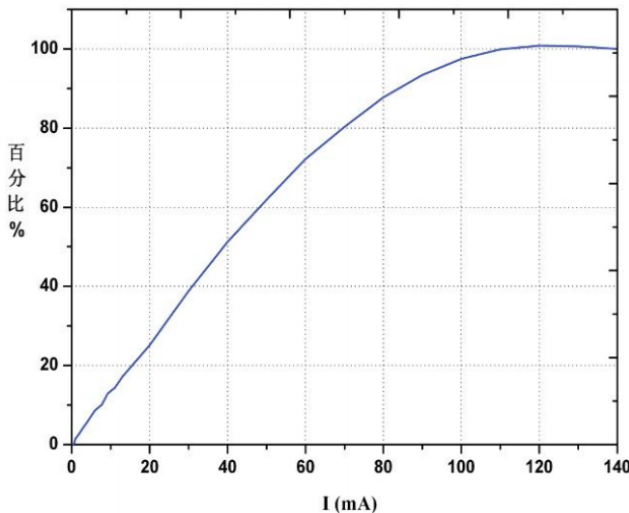

Po vs IF曲线

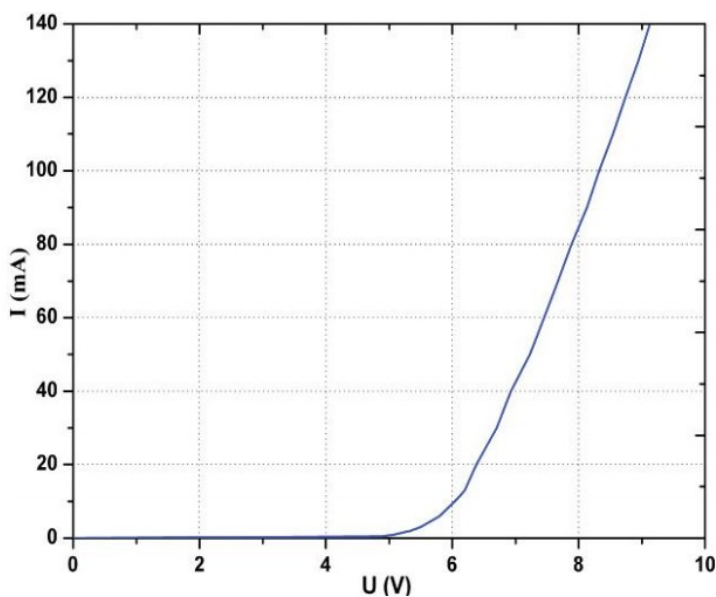

U-I特性曲线

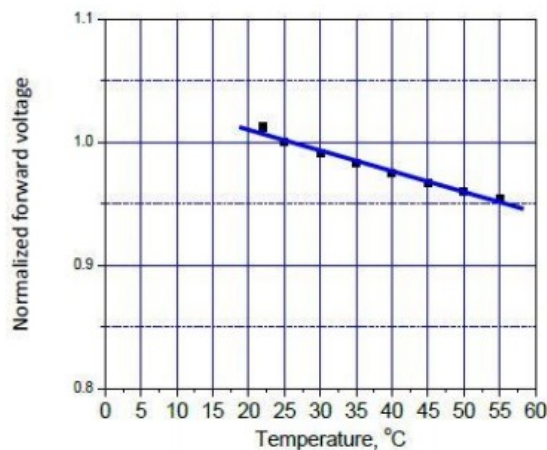
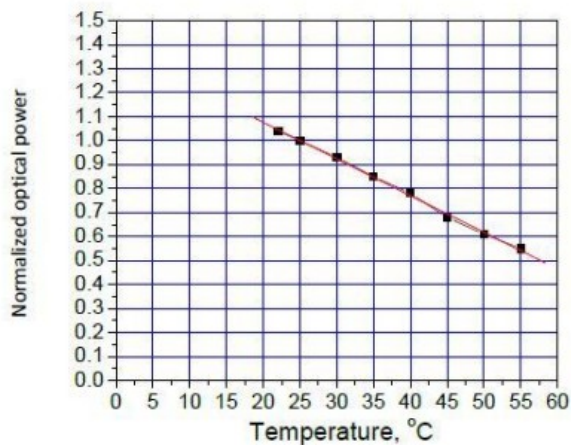

温度曲线特性



Under Development	●
Mass production	

Deep Ultraviolet LED
P/N: HL-C3535S14V-LVR15

Soldering 焊接 :

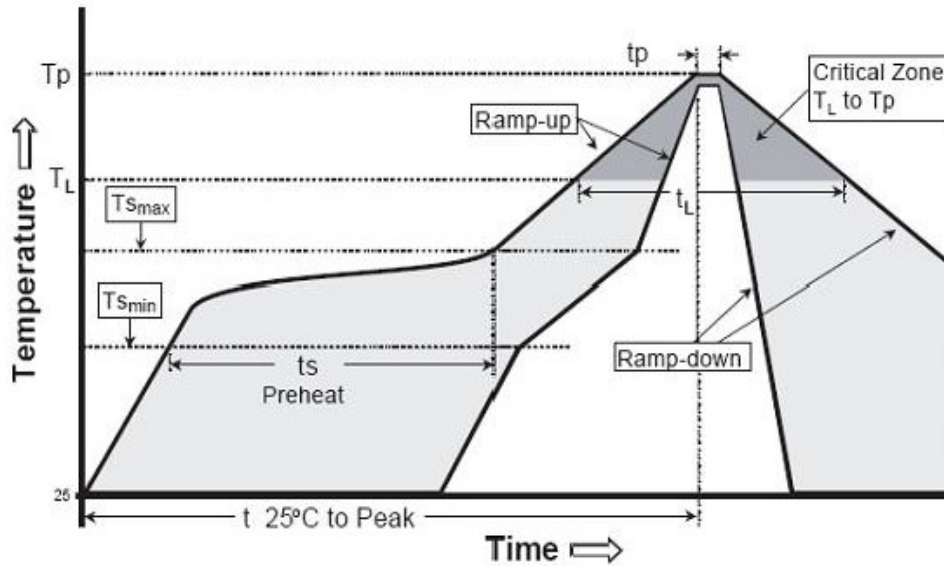

Reflow soldering 回流焊

Caution 注意:

1. wave peak and soak-stannum soldering etc. is not suitable for this products.
波峰焊、浸锡焊接不适合这个产品
2. reflow soldering should not be done more than one time
此产品只能过一次回流焊
3. The peak reflow temperature is $180 + 10^\circ C$, not more than 40 seconds
回流焊峰值温度为 $260 + 10^\circ C$, 不能超过40秒
4. Repairing should not be done after the LEDs have been soldered. When repairing is unavoidable, suitable tools have to be used.
焊接后,尽量不要对LED进行修复,如要修复,请使用正确的工具.
5. when soldering, do not put stress on the LEDs during heating.
焊接时,不要挤压灯头.
6. After soldering, do not warp the LED. do not stack PCBs or assemblies containing K Series LEDs so that anything rests on the LED lens.
焊接后,不要将LED进行堆压,不要将焊好LED的PCB板直接堆积,以免使灯头被挤压.

Test 测试

1 All ultraviolet LED products mounted on aluminum metal-core printed circuit board, can be lighted directly, but we do not recommend lighting the high power products for more than 5 seconds without a appropriate heat dissipation equipment.

所有UV LED产品安装在铝基板上,可直接点亮,但我们不建议在没有一个适当的散热设备时,照明高功率LED点亮超过5秒.



Under Development	●
Mass production	

Deep Ultraviolet LED
P/N: HL-C3535S14V-LVR15

Label 标签

 HONGLITRONIC 鸿利光电		
TYPE:		QTY:
VF:	IF:	λ_p:
P_{out}:		
DATE:		LOT.NO:

P_{out}: Optical Power 光功率档次范围

VF: Forward voltage rank 正向电压档次范围

λ_p : Peak Wavelength 峰值波长

Tape Specifications(Units:mm)载带规格 (单位:mm)

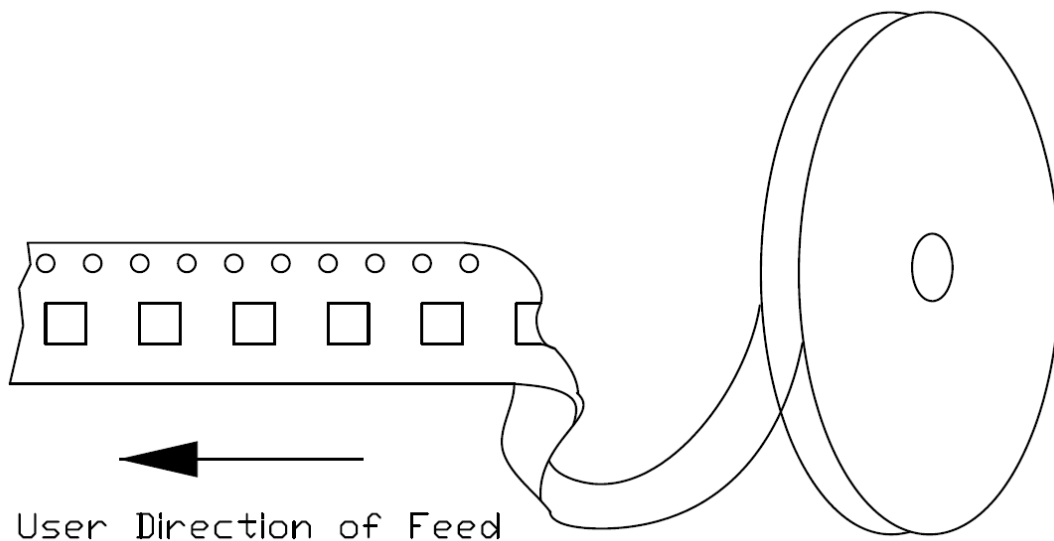
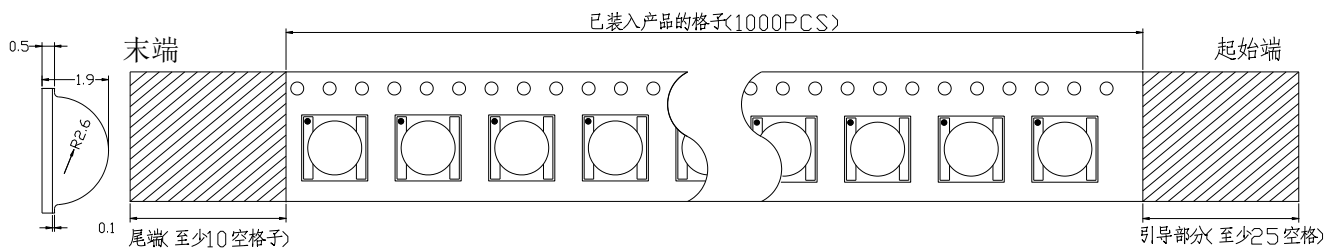



Under Development	●
Mass production	

Deep Ultraviolet LED
P/N: HL-C3535S14V-LVR15

Packing包装



Reel: 1000pcs

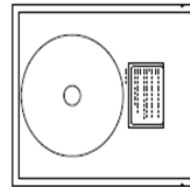
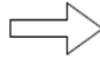

1Reel/ESD Shilding Bag

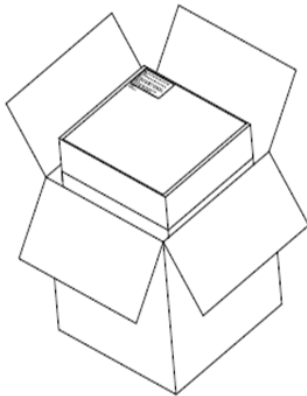

5Inner Box/Outer Box : 25000pcs

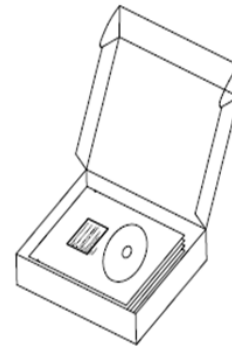

5Bags/Inner Box : 5000pcs

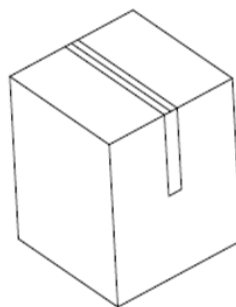

Outer Box : 25000pcs

Deep Ultraviolet LED
P/N: HL-C3535S14V-LVR15

Precaution for use 使用注意事项

1.Storage 存储

To avoid the moisture penetration ,we recommend storing LEDs in a dry box (or a desiccator) with a desiccant. The recommended conditions are temperature 5 to 30 degrees Centigrade. Humidity 60% maximum.

为了避免水分渗透，我们建议在存储LEDS（或干燥）加干燥剂.推荐的条件是温度5至30摄氏度.最大湿度60%

2.Precaution after opening packing 打开包装后的预防措施

2.1.Soldering should be done right after opening the package (within 24Hrs).

应在打开包装后（24小时内）内焊接使用。

2.2.Keeping of a fraction.尾数

-Sealing密封

-Temperature: 5~30℃ 温度：5~30℃；Humidity: less than 30%湿度：小于30%。

2.3.If the package has been opened than 1 week or the color of desiccant changed, components should be dried for 10-12 Hrs at 60±5℃.如果包装被打开超过1周或色度卡颜色的改变，组件应60±5℃除湿10-12小时。

3.Any mechanical force or any excess vibration shall not be accepted to apply during cooling process to normal temperature after soldering.产品在焊接后冷却过程中不接受任何机械力或任何多余的振动。

4.Please avoid rapid cooling after soldering.请避免焊接后快速冷却。

5.Components should not be mounted on warped direction of PCB.贴装组件的PCB不能翘曲

6.This device should not be used in any fluid such as water, oil ,organic solvent etc. When washing is required, Isopropyl Alcohol should be used.组件不应该用在任何流体如水，油，有机溶剂等。当需要清洗，应使用乙醇。

7.Avoid touching Lens parts especially by sharp tools such as pincette.避免用尖锐的工具接触透镜部分，如镊子。

8.Please do not force over 1000g impact or pressure diagonally on the silicone lens. It will cause fatal damage on this product.请不要用力超过1000g冲击或压力的对的硅透镜。它会导致本产品致命的伤害。

9.Please do not cover the silicone resin of the LEDs with other resin.

请勿使其他树脂的与发光二极管的硅树脂接触。

10.Do not use metal suction nozzle, rubber or silica gel suction nozzle is recommended.

不要使用金属吸嘴，建议使用橡胶或硅胶的吸嘴。

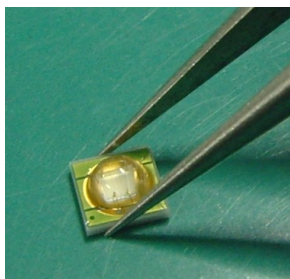

OK

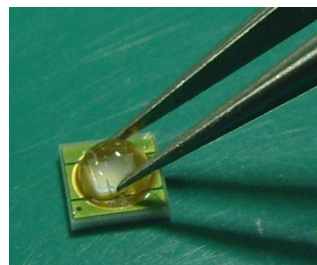

NG

Note注:

1. $2\theta_{1/2}$ is the angle from optical centerline where the luminous power is 1/2 the optical centerline value.

$2\theta_{1/2}$ 角的光学中心的光功率是1 / 2光学中心值。

3.The value only for reference.

仅供参考值



Under Development	●
Mass production	

Deep Ultraviolet LED
P/N: HL-C3535S14V-LVR15

13. Do not stack PCBs or assemblies containing the LEDs so that anything rests on the LED lens. Force applied to the LED lens may result in the lens being knocked off. PCBs or assemblies containing the LEDs should be stacked in a way to allow at least 2 cm clearance above the LED lens.

不要堆叠PCB板或包含LED组件，一切作用于LED透镜。施加到LED透镜可能导致透镜损坏。印刷电路板或组件包含LED应堆放在一个至少与LED透镜间隙2厘米的上方。



OK



OK

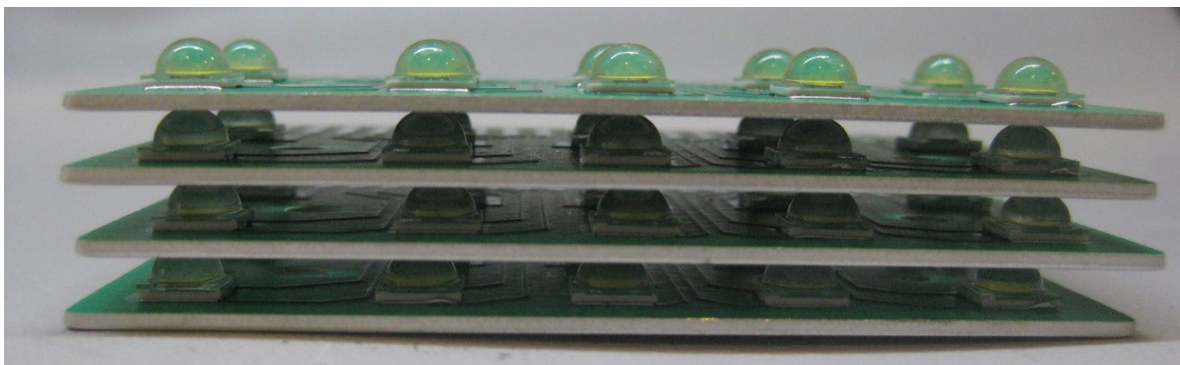

NG