



HONGLI ZHIHUI
鸿利智汇

BYTECH

Technical Data Sheet

Specification

CMH235A4V111Z1V2 (365nm)



BYTECH

Bytech Electronics CO., Ltd is the first company in China to launch the real inorganic package UV LED devices and core components for application based on CMH technology.

CMH technology platform is a kind of package technology which adopts ceramic, metal, hard glass as package materials. CMH technology platform originates independent intellectual property owned by Bytech Electronics CO., LTD, which is suitable for vacuum encapsulation, especially suitable for ensuring reliability of deep UV products.

DESIGN	CHECKED	APPROVED
2018.05.17	2018.05.17	2018.05.17
XIONG	研发专用章	TANG



Under Development	●
Mass Production	



ATTENTION
OBSERVE PRECAUTIONS
FOR HANDLING
ELECTROSTATIC
DISCHARGE
SENSITIVE
DEVICES

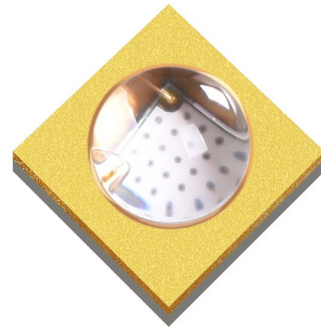

Features

- CMH real inorganic package
- Dimension 3.70mm×3.70mm×2.49mm
- Long operating life
- High reliability
- Superior ESD protection
- RoHS compliant

Applications

- Fluorescent spectroscopy
- Sensors and monitors
- Bio-analysis/detection
- Phototherapy
- UV curing
- Printing
- Coating

Package Dimensions (Unit: mm)

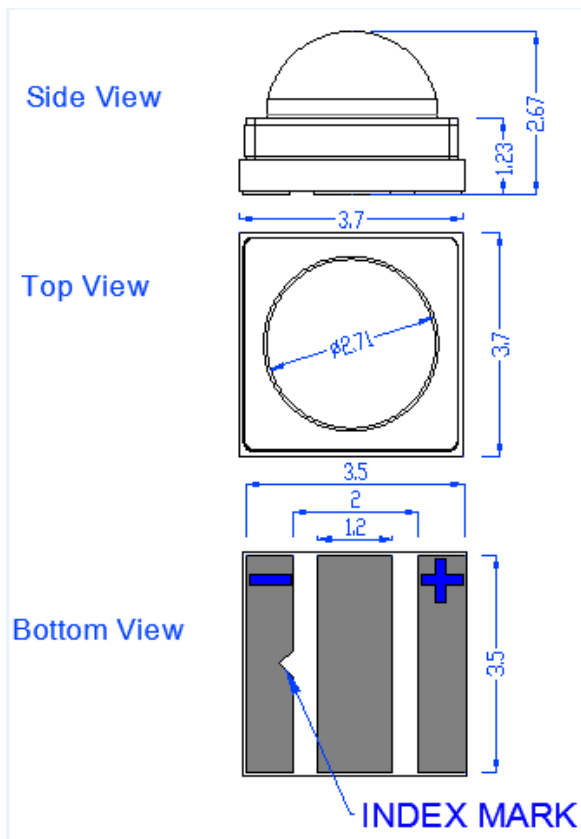

Product ID:

365nm: CMH235A4V111Z1V2

Circuit:

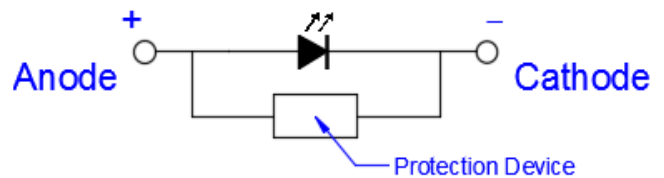

Tolerance : ± 0.20mm



Under Development	●
Mass Production	

Characteristics of UV LED

1. Electrical / Optical Characteristics (Ta=25°C, RH=40%)

Parameter	Symbol	Units	CMH235A4V111Z1V2 (IF=1000mA)
Peak Wavelength [1]	λ_p	nm	360-370
Radiant Flux [2]	Φ_e [3]	mW	1500-1800
Forward Voltage [4]	VF	V	3.5-4.5
Thermal Resistance [5]	R _{th}	°C/W	5.0
Spectrum Half Width	$\Delta\lambda$	nm	12
View Angle	2 $\theta_{1/2}$	deg	60

Notes:

- [1].Peak wavelength measurement tolerance:±3nm
- [2].Radiant flux measurement tolerance:±10%
- [3]. Φ_e is the total radiant flux as measured with an integrated sphere
- [4].Forward voltage measurement tolerance:±3%
- [5].R_{th} is the thermal resistance between junction to substrate.

2. Absolute Maximum Ratings (Ta=25°C, RH=40%)

Parameter	Symbol	Units	CMH235A4V111Z1V2
Maximum Rating Forward Current	I _{Fmax}	mA	1200
Maximum Rating Junction Temperature	T _{jmax}	°C	125
Operating Temperature Range	T _{opr}	°C	-10 ~ +85
Storage Temperature Range	T _{stg}	°C	-40 ~ +100

Notes:

Operating the LED beyond the listed maximum ratings may affect device's reliability and cause permanent damage. These or any other conditions beyond those indicated under recommended operating conditions are not implied. The exposure to the absolute maximum rated conditions may affect device reliability.



Under Development	●
Mass Production	

Characteristics Diagrams

1. Relative Spectrum Power Distribution

IF=1000mA Ta=25°C, RH=40%

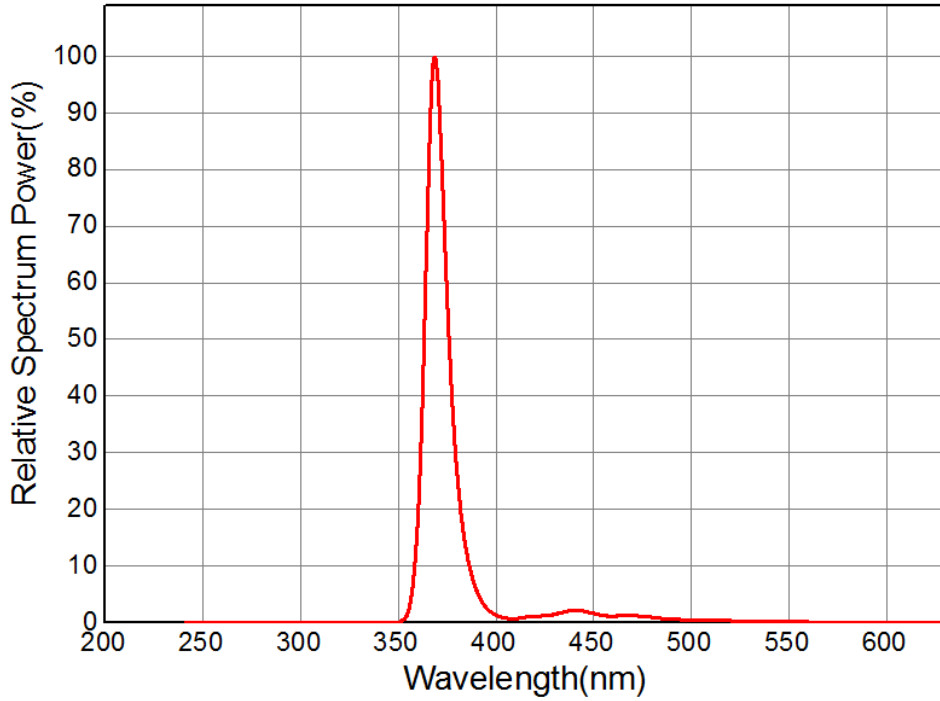

2. Forward Voltage vs Forward Current

Ta=25°C, RH=40%

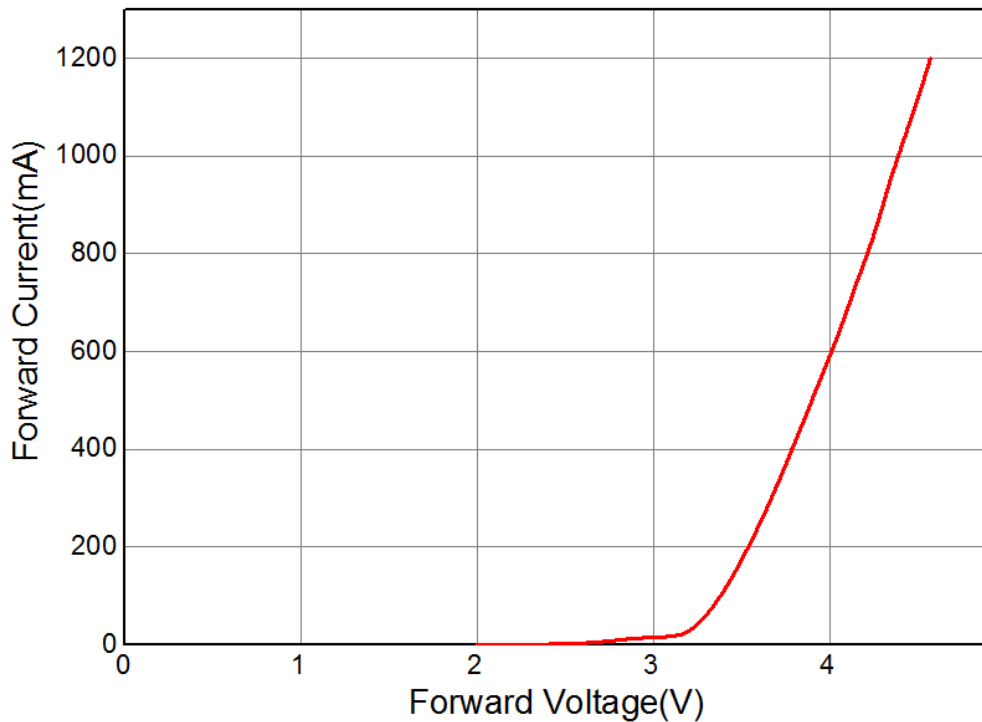



Under Development	●
Mass Production	

3. Relative Radiation Flux vs Forward Current

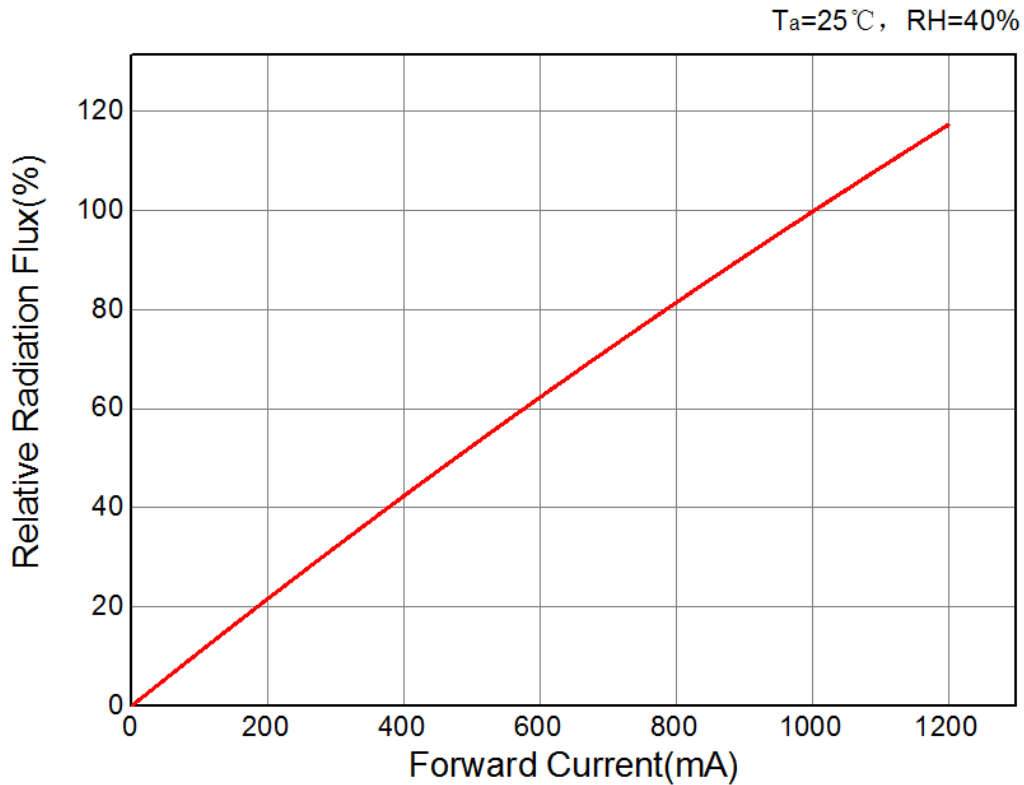

4. Peak Wavelength vs Forward Current

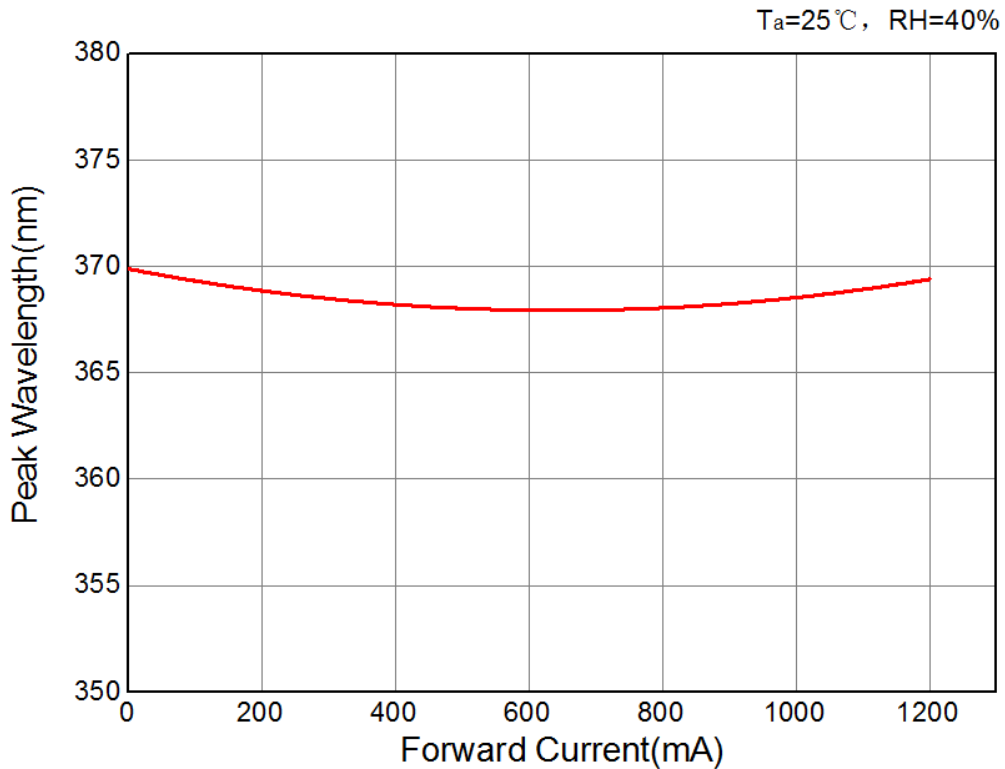



Under Development	●
Mass Production	

5. Spectrum Half-Wave Width vs Forward Current

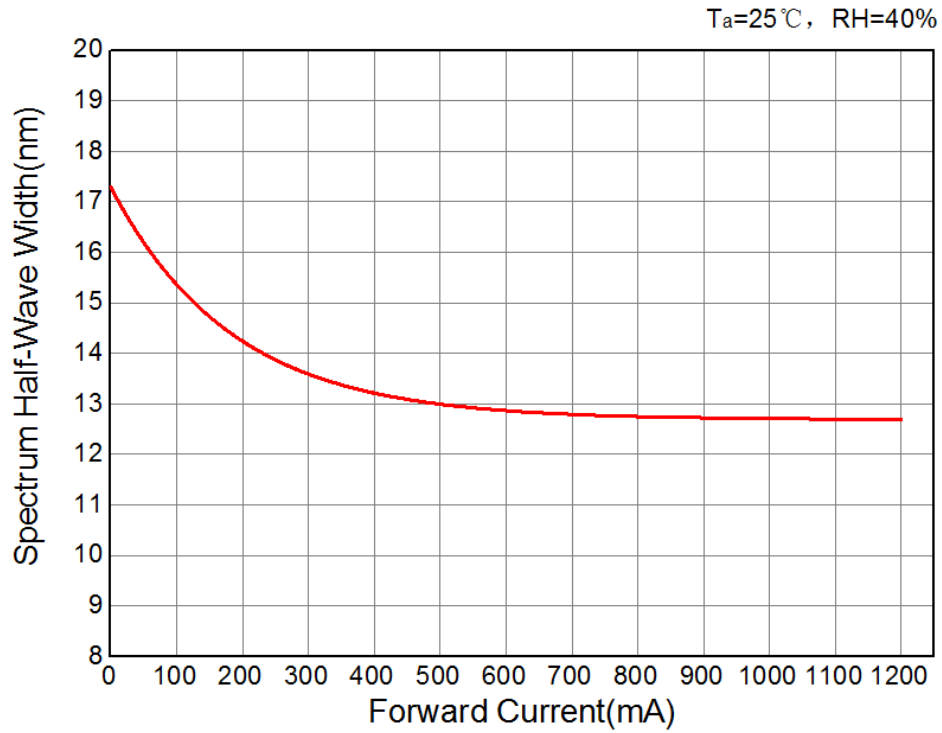

6. Spatial Distribution Graph

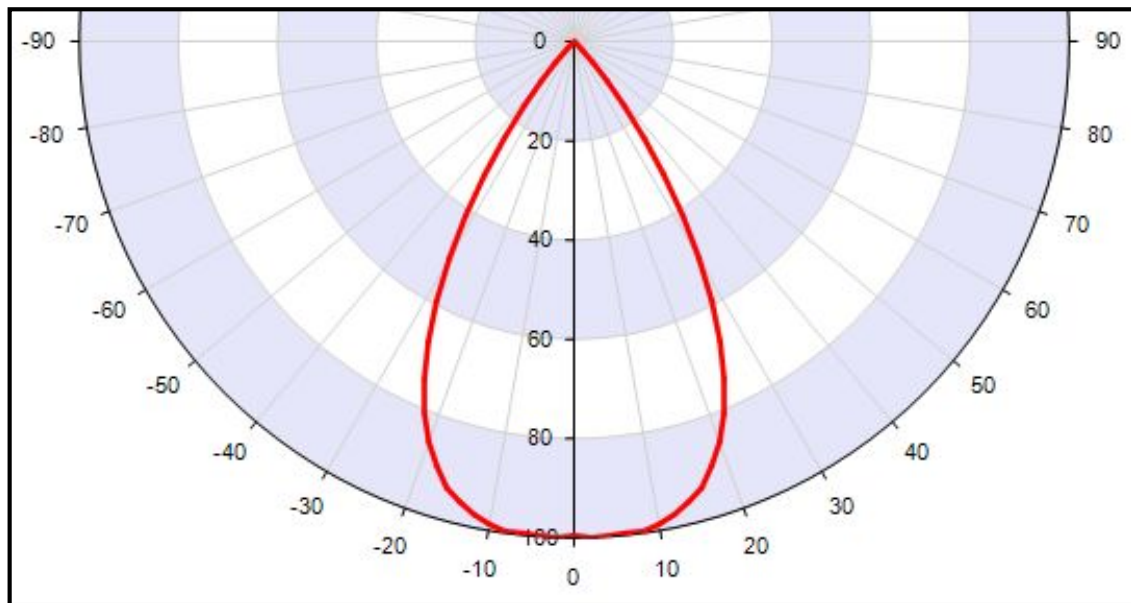



Under Development	●
Mass Production	

Product Application Information

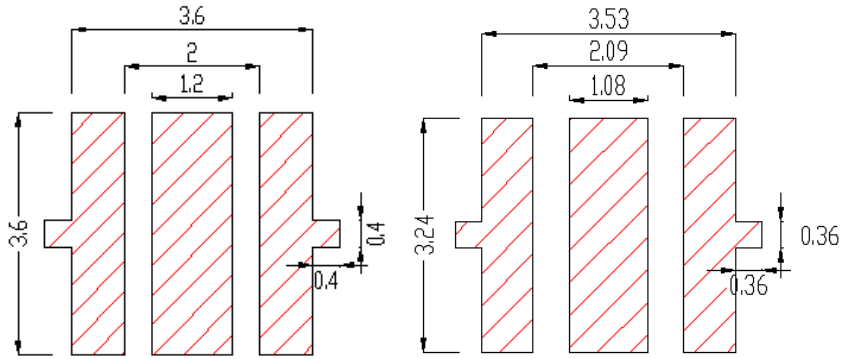
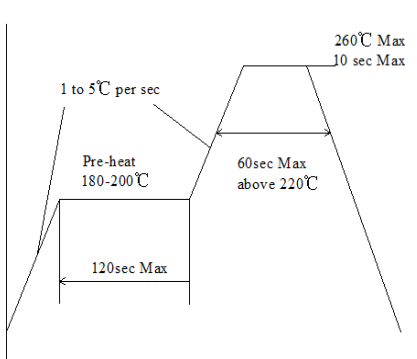

Recommended Reflow Soldering Condition
(Lead-free solder)

Recommended Soldering pad Layout
(Unit: mm)

Recommended Soldering Mask Layout
(Unit: mm)

Notes:

- *This LED is designed to be reflow soldered on to a PCB. If dip soldered or hand soldered, Bytech cannot guarantee its reliability.
- *Reflow soldering must not be performed more than twice.
- *Avoid rapid cooling. Ramp down the temperature gradually from the peak temperature.
- *Nitrogen reflow soldering is recommended. Air flow soldering conditions can cause optical degradation, caused by heat and/or atmosphere.
- *Since the glass used in the encapsulating glass is fragile, do not press on the hermetic glass. pressure can cause nicks, chip-outs, Sealant layer and deformation, and wire breaks, decreasing reliability
- *Repairing should not be done after the LEDs have been soldered.
It should be confirmed beforehand whether the characteristics of the LEDs will or will not be damaged by repairing.
- *The Die Heat Sink should be soldered to customer PCB. If it is difficult or impossible, use high heat-dissipating adhesive.
- *When soldering, do not apply stress to the LED while the LED is hot.
- *When using a pick and place machine, choose an appropriate nozzle for this product.
- *When flux is used, it should be a halogen free flux. Ensure that the manufacturing process is not designed in a manner Where the flux will come in contact with the LEDs.
- *Make sure that there are no issues with the type and amount of solder that is being used.



Under Development	●
Mass Production	

CAUTIONS

1. Handling Precautions

- Do not handle the LEDs with bare hands as it will contaminate the LEDs surface and may affect the optical characteristics.
- When handling the product with tweezers, be careful not to apply excessive force to the glass. Otherwise, the glass can be cut, chipped, delaminate or deformed, causing wire-bond breaks and catastrophic failures.
 - Dropping the product may cause damage.

2. Electrostatic Discharge (ESD)

- The product are sensitive to static electricity or surge voltage. ESD can damage a die and its reliability. When handling the products, the following measure against electrostatic discharge are strongly recommended:

Eliminating wrist strap, ESD footwear, clothes, and floors

Grounded workstation equipment and tools

ESD table/shelf mat made of conductive materials

- Ensure that tools, jigs and machines that are being used are properly grounded and that proper grounding techniques are used in work areas. For devices/equipment that mount the LEDs, protection against surge voltages should also be used.
- The customer is advised to check if the LEDs are damage by ESD
When performing the characteristics inspection of the LEDs in the application.
Damage can be detected with a forward voltage measurement at low current($\leq 1\text{mA}$).

3. Eye Safety

- Please proceed with caution when handling any UVLEDs driven at low or high current. Since UV light can be harmful to eyes, do Not look directly into the UV light, even through an optical instrument.
- UV protective glasses are required to use in order to avoid damage by UV light in case of viewing UV light directly.



