



2N6718

NPN SILICON TRANSISTOR

NPN GENERAL PLANAR TRANSISTOR

■ DESCRIPTION

The UTC **2N6718** is designed for general purpose medium power amplifier and switching applications.

■ FEATURES

- * High Power: 850mW
- * High Current: 1A

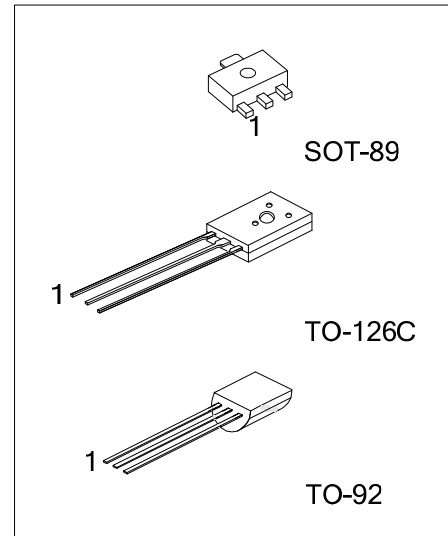

■ ORDERING INFORMATION

Ordering Number		Package	Pin Assignment			Packing
Lead Free	Halogen Free		1	2	3	
-	2N6718G-x-AB3-R	SOT-89	B	C	E	Tape Reel
2N6718L-x-T6C-K	2N6718G-x-T6C-K	TO-126C	E	C	B	Bulk
2N6718L-x-T92-B	2N6718G-x-T92-B	TO-92	E	C	B	Tape Box
2N6718L-x-T92-K	2N6718G-x-T92-K	TO-92	E	C	B	Bulk

Note: Pin Assignment: B: Base C: Collector E: Emitter

<p>2N6718G-x-AB3-R</p> <ul style="list-style-type: none"> (1) Packing Type (2) Package Type (3) Rank (4) Green Package 	<ul style="list-style-type: none"> (1) B: Tape Box, K: Bulk, R: Tape Reel (2) AB3: SOT-89, T6C: TO-126C, T92: TO-92 (3) x: refer to Classification of h_{FE2} (4) G: Halogen Free and Lead Free, L: Lead Free
--	--

■ MARKING

SOT-89	TO-126C	TO-92

■ ABSOLUTE MAXIMUM RATING ($T_A=25^\circ\text{C}$, unless otherwise specified)

PARAMETER		SYMBOL	RATINGS	UNIT
Collector-Base Voltage		V_{CBO}	100	V
Collector-Emitter Voltage		V_{CEO}	100	V
Emitter-Base Voltage		V_{EBO}	5	V
Collector Current (Continue)		I_C	1	A
Collector Current (Pulse)		I_C	2	A
Total Power Dissipation	SOT-89	P_D	0.5	W
	TO-126C		1.6	W
	TO-92		850	mW
Junction Temperature		T_J	+150	$^\circ\text{C}$
Operating Temperature		T_{OPR}	-40 ~ +125	$^\circ\text{C}$
Storage Temperature		T_{STG}	-55 ~ +150	$^\circ\text{C}$

Note Absolute maximum ratings are those values beyond which the device could be permanently damaged. Absolute maximum ratings are stress ratings only and functional device operation is not implied.

■ ELECTRICAL CHARACTERISTICS ($T_A=25^\circ\text{C}$, unless otherwise specified)

PARAMETER	SYMBOL	TEST CONDITIONS	MIN	TYP	MAX	UNIT
Collector-Base Breakdown Voltage	BV_{CBO}	$I_C=100\mu\text{A}$	100			V
Collector-Emitter Breakdown Voltage (note)	BV_{CEO}	$I_C=1\text{mA}$	100			V
Emitter-Base Breakdown Voltage	BV_{EBO}	$I_E=10\mu\text{A}$	5			V
Collector-Emitter Saturation Voltage	$V_{CE(SAT)}$	$I_C=350\text{mA}$, $I_B=35\text{mA}$			350	mV
Collector Cut-Off Current	I_{CBO}	$V_{CB}=80\text{V}$			100	nA
DC Current Gain	h_{FE1}	$V_{CE}=1\text{V}$, $I_C=50\text{mA}$	80			
	h_{FE2}	$V_{CE}=1\text{V}$, $I_C=250\text{mA}$	50		300	
	h_{FE3}	$V_{CE}=1\text{V}$, $I_C=500\text{mA}$	20			
Current Gain - Bandwidth Product	f_T	$V_{CE}=10\text{V}$, $I_C=50\text{mA}$, $f=100\text{MHz}$	50			MHz
Output Capacitance	C_{ob}	$V_{CB}=10\text{V}$, $I_E=0$, $f=1\text{MHz}$			20	pF

Note: Pulse test: PulseWidth \leq 380 μs , Duty Cycle \leq 2%

■ CLASSIFICATION OF h_{FE2}

RANK	A	B
RANGE	50~115	95~300

TYPICAL CHARACTERISTICS

Current Gain vs. Collector Current

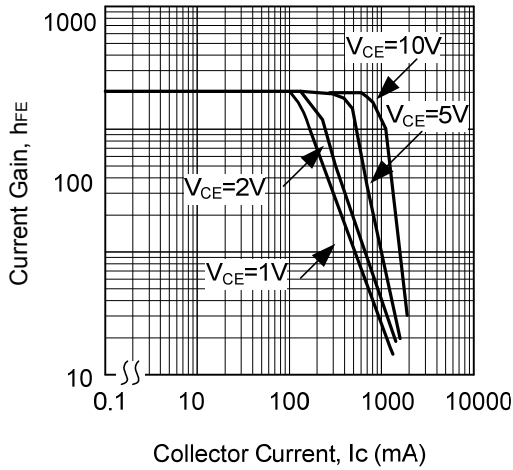

Saturation Voltage vs. Collector Current

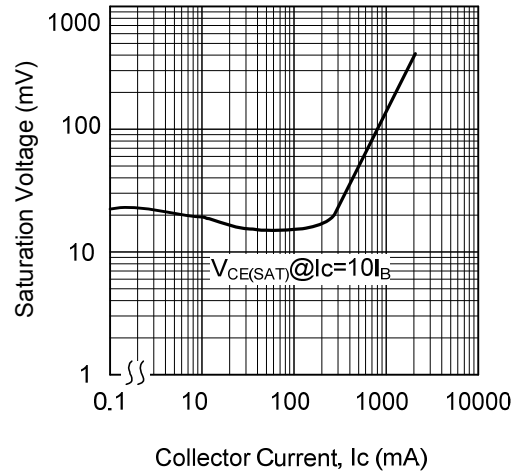

Saturation Voltage vs. Collector Current

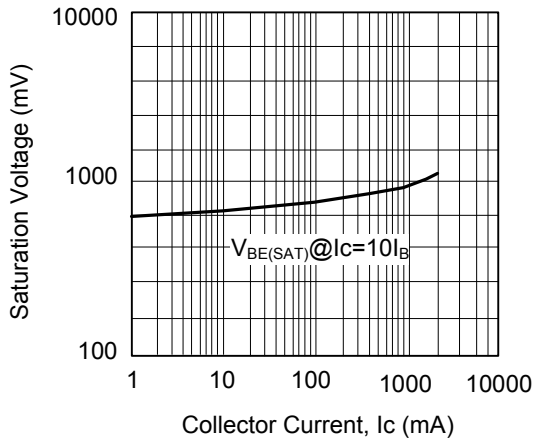

Collector Output Capacitance

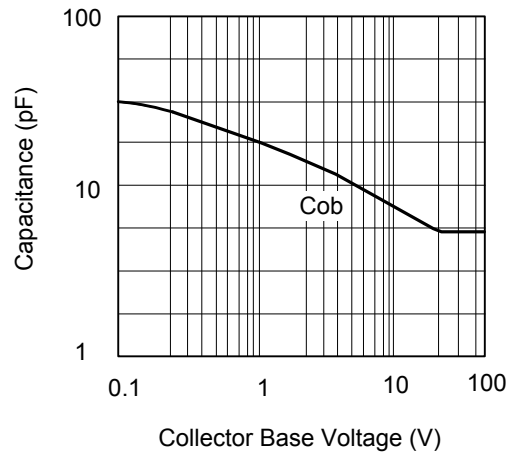

Safe Operating Area

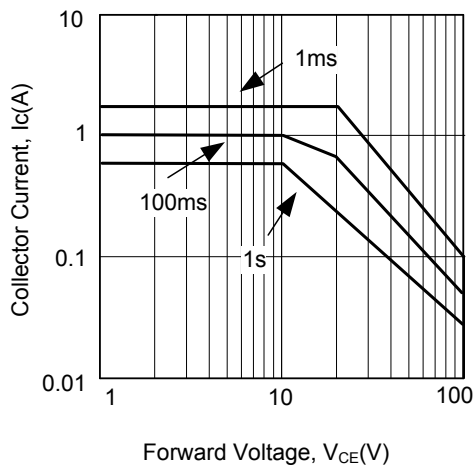

Cutoff Frequency vs. Collector Current

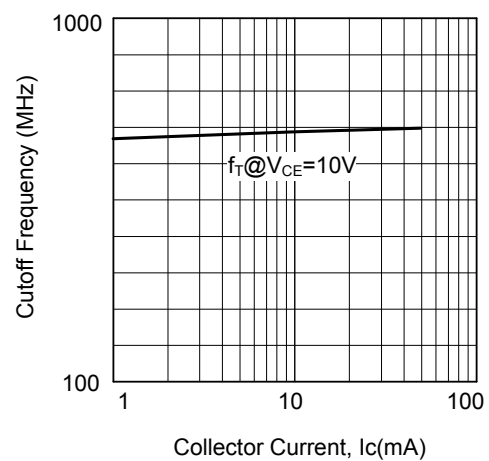

■ TYPICAL CHARACTERISTICS

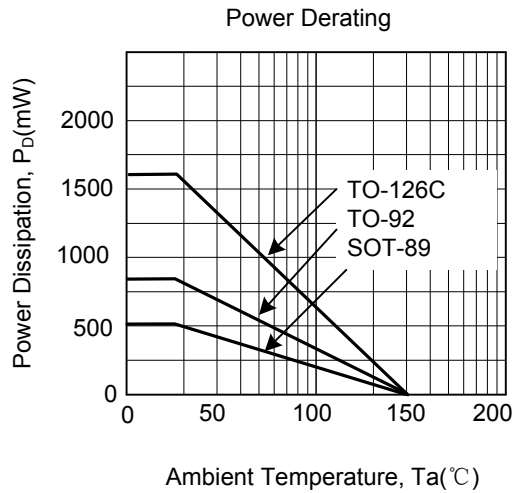

UTC assumes no responsibility for equipment failures that result from using products at values that exceed, even momentarily, rated values (such as maximum ratings, operating condition ranges, or other parameters) listed in products specifications of any and all UTC products described or contained herein. UTC products are not designed for use in life support appliances, devices or systems where malfunction of these products can be reasonably expected to result in personal injury. Reproduction in whole or in part is prohibited without the prior written consent of the copyright owner. The information presented in this document does not form part of any quotation or contract, is believed to be accurate and reliable and may be changed without notice.