



TL1093

LINEAR INTEGRATED CIRCUIT

PROGRAMMABLE PRECISION REFERENCE

DESCRIPTION

The UTC **TL1093** is a three-terminal adjustable regulator with a guaranteed thermal stability over applicable temperature ranges. The output voltage may be set to any value between V_{REF} (approximately 2.5V) and 36 V with two external resistors. It provides very wide applications, including shunt regulator, series regulator, switching regulator, voltage reference and others.

FEATURES

- *Programmable output Voltage to 36V.
- *Low dynamic output impedance 0.2Ω.
- *Sink current capability of 1.0 to 100mA.
- *Equivalent full-range temperature coefficient of 50ppm/ °C typical for operation over full rated operating temperature range.

ORDERING INFORMATION

Ordering Number		Package	Pin Assignment					Packing
Lead Free	Halogen Free		1	2	3	4	5	
TL1093L-AB3-R	TL1093G-AB3-R	SOT-89	K	A	R	-	-	Tape Reel
TL1093L-AF5-R	TL1093G-AF5-R	SOT-25	R	A	K	NC	A	Tape Reel

Note: Pin Code: K: Cathode A: Anode R: Reference NC: No Connection

<p>TL1093L-AB3-R</p> <p>(1) Packing Type (2) Package Type (3) Lead Plating</p>	<p>(1) R: Tape Reel (2) AB3: SOT-89, AF5: SOT-25 (3) L: Lead Free, G: Halogen Free</p>
--	--

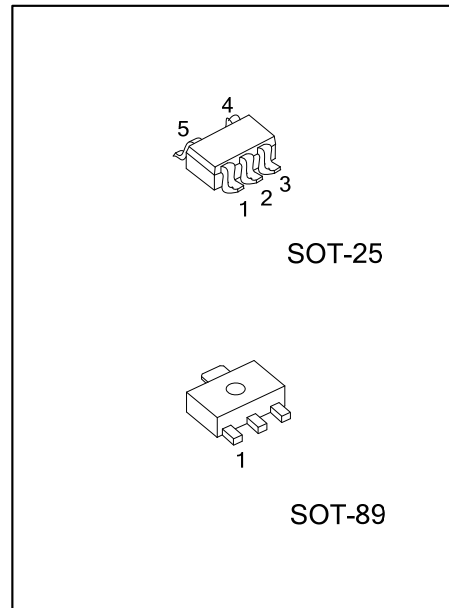

■ BLOCK DIAGRAM

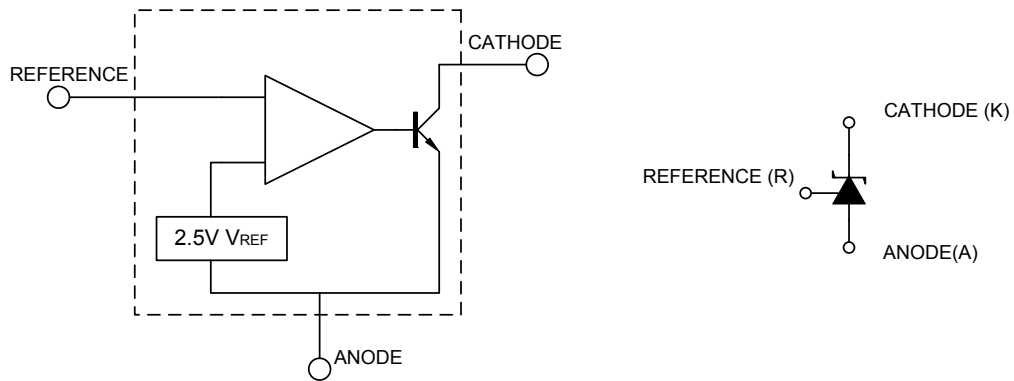

■ ABSOLUTE MAXIMUM RATINGS (Operating temperature range applies unless otherwise specified)

PARAMETER		SYMBOL	RATINGS	UNIT
Cathode Voltage		V_{KA}	37	V
Cathode Current Range(Continuous)		I_{KA}	-100 ~ +150	mA
Reference Input Current Range		I_{REF}	-0.05 ~ +10	mA
Power Dissipation	SOT-89	P_D	800	mW
	SOT-25		300	mW
Operating Junction Temperature		T_J	+150	°C
Operating Ambient Temperature		T_{OPR}	-40 ~ +85	°C
Storage Temperature		T_{STG}	-65 ~ +150	°C

Note: Absolute maximum ratings are those values beyond which the device could be permanently damaged. Absolute maximum ratings are stress ratings only and functional device operation is not implied.

■ RECOMMENDED OPERATING CONDITIONS

PARAMETER	SYMBOL	MIN	TYP	MAX	UNIT
Cathode Voltage	V_{KA}	V_{REF}		36	V
Cathode Current	I_{KA}	1		100	mA

■ ELECTRICAL CHARACTERISTICS ($T_C=25^\circ\text{C}$, unless otherwise specified.)

PARAMETER	SYMBOL	TEST CONDITIONS	MIN	TYP	MAX	UNIT
Reference Input Voltage	V_{REF}	$V_{KA}=V_{REF}, I_{KA}=10\text{mA}$	2.470	2.495	2.520	V
Deviation of reference Input Voltage Over temperature	$\frac{\Delta V_{REF}}{\Delta T}$	$V_{KA}=V_{REF}, I_{KA}=10\text{mA}$ $0^\circ\text{C} \leq T_a \leq 70^\circ\text{C}$		4.5	17	mV
Ratio of Change in Reference Input Voltage to the Change in Cathode Voltage	$\frac{\Delta V_{REF}}{\Delta V_{KA}}$	$I_{KA}=10\text{mA}$	$\Delta V_{KA}=10\text{V} \sim V_{REF}$	-1.0	-2.7	mV/V
			$\Delta V_{KA}=36\text{V} \sim 10\text{V}$	-0.5	-2.0	mV/V
Reference Input Current	I_{REF}	$I_{KA}=10\text{mA}, R_1=10\text{k}\Omega, R_2=\infty$		1.5	4	μA
Deviation of Reference Input Current Over Full Temperature Range	$\frac{\Delta I_{REF}}{\Delta T}$	$I_{KA}=10\text{mA}, R_1=10\text{k}\Omega, R_2=\infty$ $T_a = \text{full Temperature}$		0.4	1.2	μA
Minimum Cathode Current for Regulation	$I_{KA(MIN)}$	$V_{KA}=V_{REF}$		0.19	0.5	mA
Off-State Cathode Current	$I_{KA(OFF)}$	$V_{KA}=36\text{V}, V_{REF}=0$		0.05	1.0	μA
Dynamic Impedance	Z_{KA}	$V_{KA}=V_{REF}, I_{KA}=1 \text{ to } 100\text{mA}$ $f \leq 1.0\text{kHz}$		0.15	0.5	Ω

TEST CIRCUIT

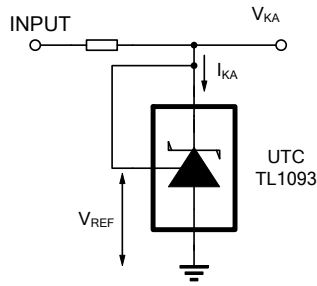

For $V_{KA} = V_{REF}$

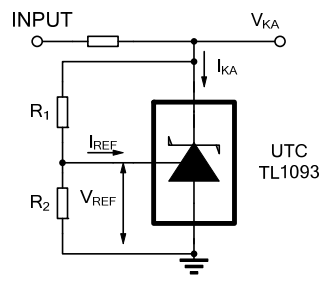

$$V_{KA} = V_{REF} \times (1 + R_1/R_2) + I_{REF} \times R_1$$

For $V_{KA} \geq V_{REF}$

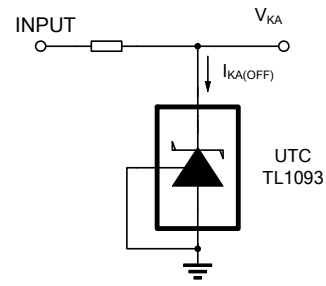

For $I_{KA(OFF)}$

APPLICATION CIRCUIT

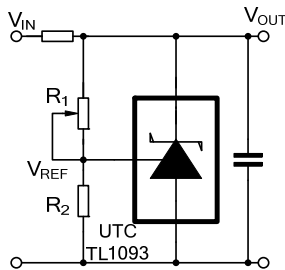

$$V_{OUT} = (1 + R_1/R_2) \times V_{REF}$$

Shutdown Regulator

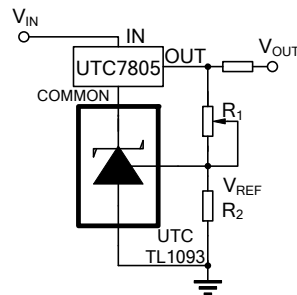

$$V_{OUT} = (1 + R_1/R_2) \times V_{REF}$$

Minimum $V_{OUT} = V_{REF} + 5V$

Output Control of a Three-Terminal Fixed Regulator

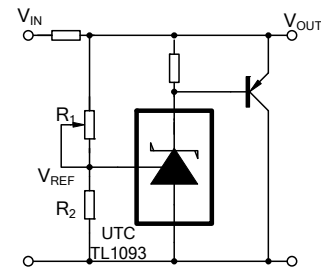

$$V_{OUT} = (1 + R_1/R_2) \times V_{REF}$$

Higher-current Shunt Regulator

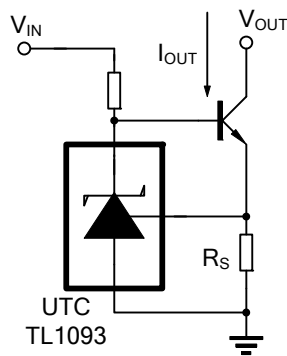

$$I_{OUT} = V_{REF}/R_S$$

Constant-current Sink

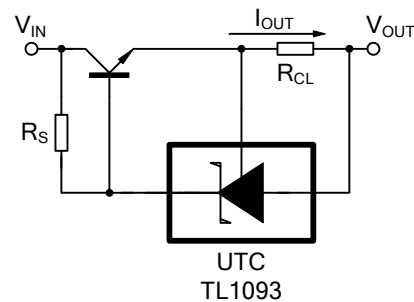

$$R_S = V_{REF}/R_{CL}$$

Current Limiting or Current Source

■ TYPICAL CHARACTERISTICS

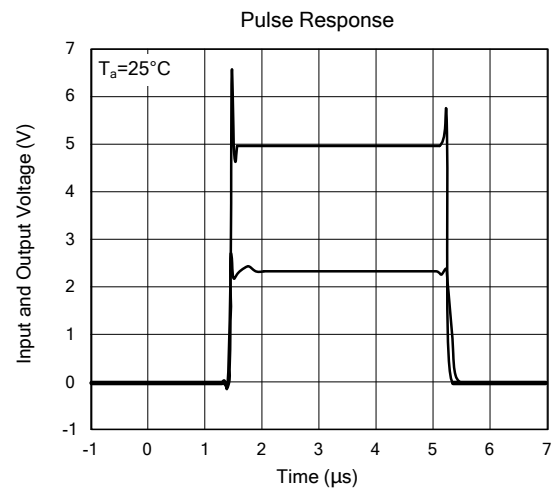
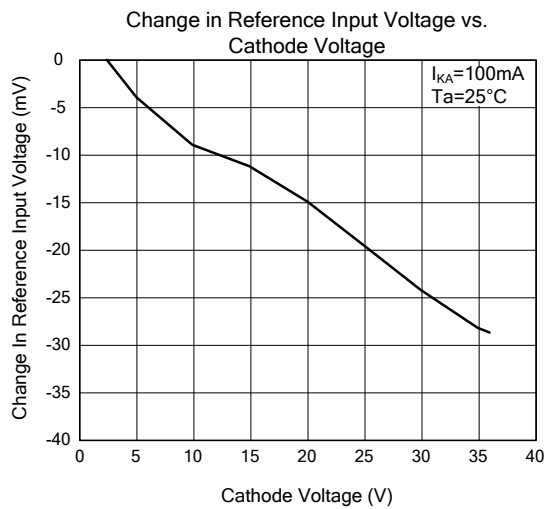
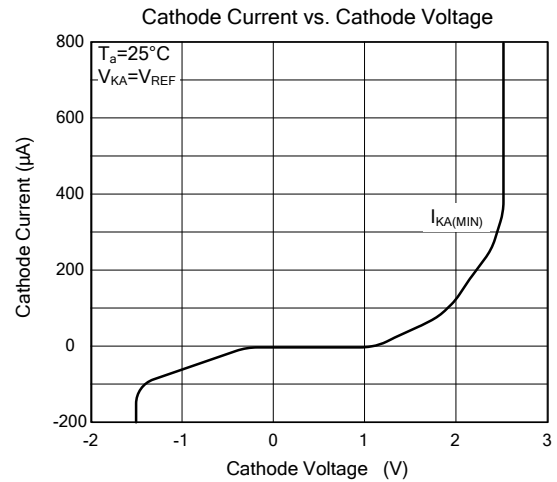
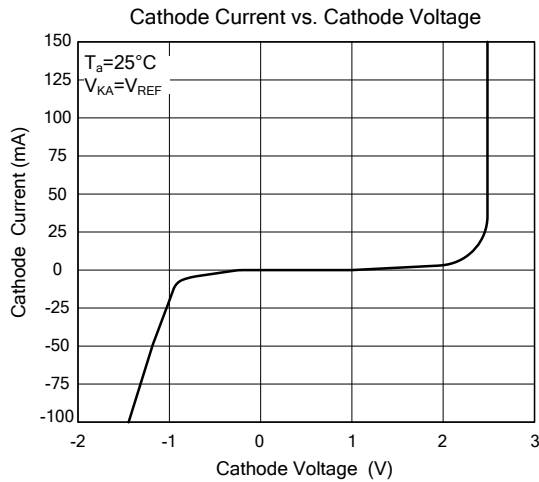

UTC assumes no responsibility for equipment failures that result from using products at values that exceed, even momentarily, rated values (such as maximum ratings, operating condition ranges, or other parameters) listed in products specifications of any and all UTC products described or contained herein. UTC products are not designed for use in life support appliances, devices or systems where malfunction of these products can be reasonably expected to result in personal injury. Reproduction in whole or in part is prohibited without the prior written consent of the copyright owner. The information presented in this document does not form part of any quotation or contract, is believed to be accurate and reliable and may be changed without notice.