



UTD452

Power MOSFET

N-CHANNEL ENHANCEMENT MODE

DESCRIPTION

The **UTD452** uses advanced trench technology to provide excellent $R_{DS(ON)}$, low gate charge and operation with low gate voltages. This device is suitable for use as a load switch or in PWM applications.

FEATURES

- * $R_{DS(ON)} < 8.5m\Omega @ V_{GS}=10V$
- * $R_{DS(ON)} < 14m\Omega @ V_{GS}=4.5V$
- * Low capacitance
- * Low gate charge
- * Fast switching capability
- * Avalanche energy specified

SYMBOL

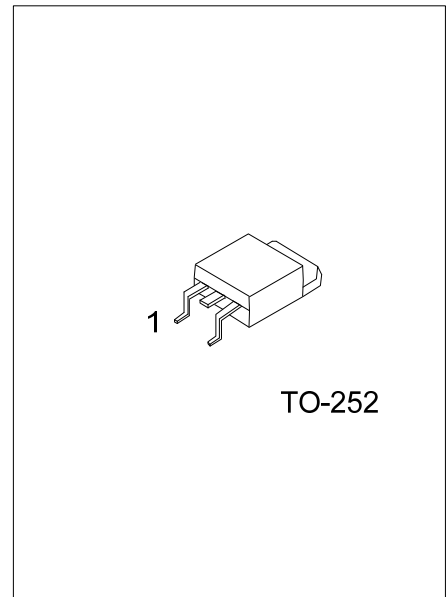
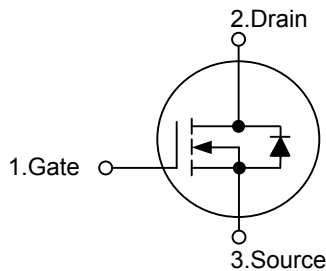

Lead-free: UTD452L
 Halogen-free: UTD452G

ORDERING INFORMATION

Ordering Number			Package	Pin Assignment			Packing
Normal	Lead Free	Halogen Free		1	2	3	
UTD452-TN3-R	UTD452L-TN3-R	UTD452G-TN3-R	TO-252	G	D	S	Tape Reel
UTD452-TN3-T	UTD452L-TN3-T	UTD452G-TN3-T	TO-252	G	D	S	Tube

<p>UTD452L-TN3-R</p> <p>(1)Packing Type</p> <p>(2)Package Type</p> <p>(3)Lead Plating</p>	<p>(1) R: Tape Reel, T: Tube</p> <p>(2) TN3: TO-252</p> <p>(3) G: Halogen Free, L: Lead Free, Blank: Pb/Sn</p>
---	--

ABSOLUTE MAXIMUM RATINGS ($T_a=25^\circ C$, unless otherwise specified)

PARAMETER	SYMBOL	RATINGS	UNIT
Drain-Source Voltage	V_{DSS}	25	V
Gate-Source Voltage	V_{GSS}	± 20	V
Continuous Drain Current	I_D	55	A
Pulsed Drain Current	I_{DM}	100	A
Avalanche Current	I_{AR}	30	A
Repetitive avalanche energy L=0.1mH	E_{AR}	135	mJ
Power Dissipation	P_D	50	W
Junction Temperature	T_J	+175	$^{\circ}C$
Storage Temperature	T_{STG}	-55 ~ +175	$^{\circ}C$

Note: 1. Absolute maximum ratings are those values beyond which the device could be permanently damaged.

Absolute maximum ratings are stress ratings only and functional device operation is not implied.

2. Pulse width limited by $T_{J(MAX)}$

■ THERMAL DATA

PARAMETER	SYMBOL	MIN	TYP	MAX	UNIT
Junction-to-Ambient	θ_{JA}		39	50	$^{\circ}C/W$
Junction-to-Case	θ_{JC}		2.5	3	$^{\circ}C/W$

■ ELECTRICAL CHARACTERISTICS ($T_J=25^{\circ}C$, unless otherwise specified)

PARAMETER	SYMBOL	TEST CONDITIONS	MIN	TYP	MAX	UNIT	
OFF CHARACTERISTICS							
Drain-Source Breakdown Voltage	BV_{DSS}	$V_{GS}=0V, I_D=250\mu A$	25			V	
Drain-Source Leakage Current	I_{DSS}	$V_{DS}=20V, V_{GS}=0V$			1	μA	
Gate-Source Leakage Current	I_{GSS}	$V_{DS}=0V, V_{GS}=\pm 20V$			100	nA	
ON CHARACTERISTICS							
Gate Threshold Voltage	$V_{GS(TH)}$	$V_{DS}=V_{GS}, I_D=250\mu A$	1	1.8	3	V	
On State Drain Current	$I_{D(ON)}$	$V_{DS}=5V, V_{GS}=10V$	100			A	
Static Drain-Source On-Resistance	$R_{DS(ON)}$	$V_{GS}=10V, I_D=30A$		6.5	8.5	m Ω	
		$V_{GS}=4.5V, I_D=20A$		11.5	14		
Forward Transconductance	g_{FS}	$V_{DS}=5V, I_D=10A$		35		S	
DYNAMIC PARAMETERS							
Input Capacitance	C_{ISS}	$V_{DS}=12.5V, V_{GS}=0V, f=1MHz$		1230	1476	pF	
Output Capacitance	C_{OSS}			315			pF
Reverse Transfer Capacitance	C_{RSS}			190			pF
SWITCHING PARAMETERS							
Total Gate Charge	10V	Q_G	$V_{DS}=12.5V, V_{GS}=10V, I_D=20A$	26.4	32	nC	
	4.5V			13.5			
Gate Source Charge	Q_{GS}	3.9			nC		
Gate Drain Charge	Q_{GD}	7.75			nC		
Turn-ON Delay Time	$t_{D(ON)}$	6.5			ns		
Turn-ON Rise Time	t_R	10			ns		
Turn-OFF Delay Time	$t_{D(OFF)}$	22.7			ns		
Turn-OFF Fall-Time	t_F	6.2			ns		
SOURCE- DRAIN DIODE RATINGS AND CHARACTERISTICS							
Diode Forward Voltage	V_{SD}	$I_S=1A, V_{GS}=0V$			0.72	1	V
Maximum Body-Diode Continuous Current	I_S				55	A	
Body Diode Reverse Recovery Time	t_{RR}	$I_F=20A, di/dt=100A/\mu s$		23.06	27.5	ns	
Body Diode Reverse Recovery Charge	Q_{RR}	$I_F=20A, di/dt=100A/\mu s$		15.25		nC	

TYPICAL CHARACTERISTICS

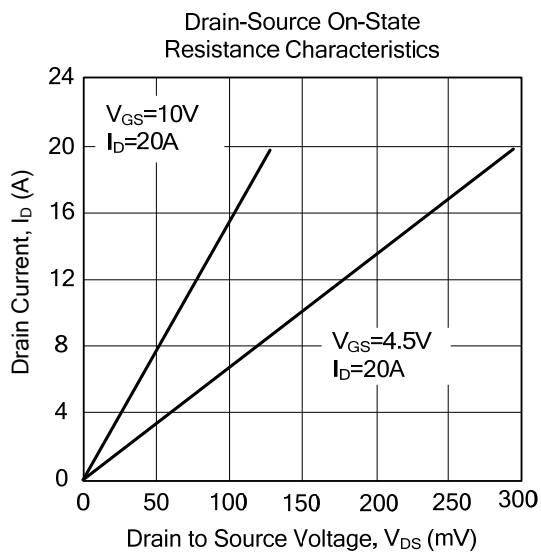
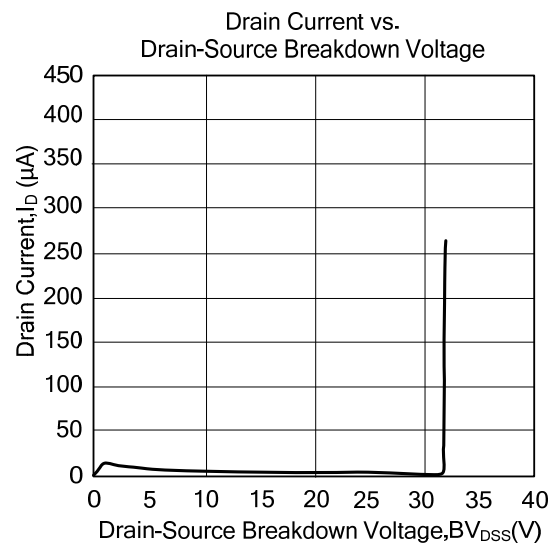
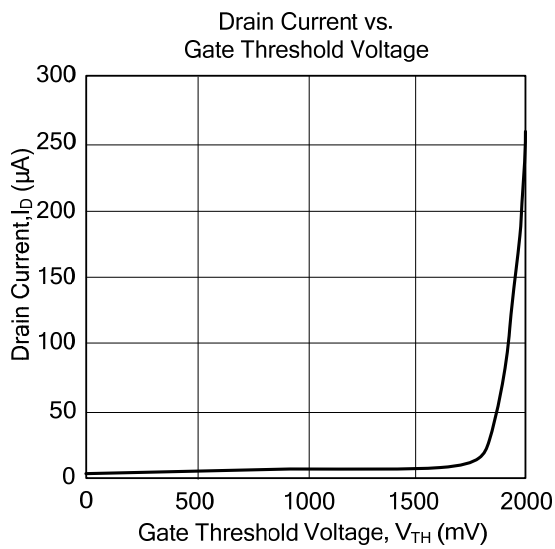
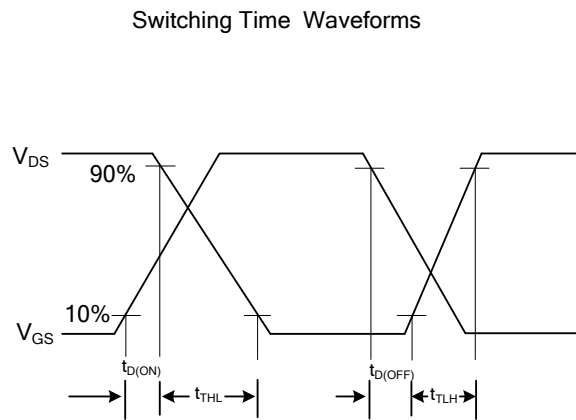
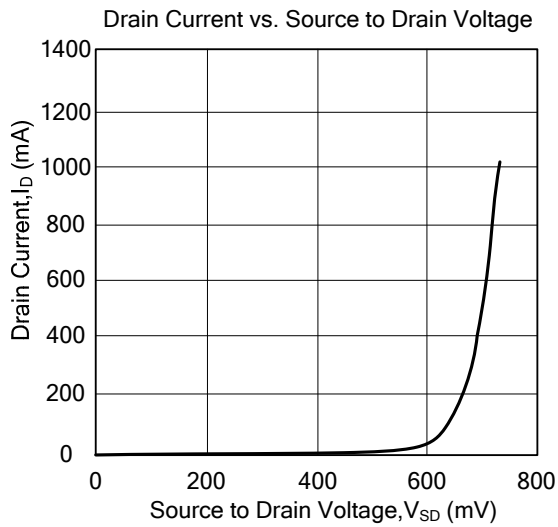

UTC assumes no responsibility for equipment failures that result from using products at values that exceed, even momentarily, rated values (such as maximum ratings, operating condition ranges, or other parameters) listed in products specifications of any and all UTC products described or contained herein. UTC products are not designed for use in life support appliances, devices or systems where malfunction of these products can be reasonably expected to result in personal injury. Reproduction in whole or in part is prohibited without the prior written consent of the copyright owner. The information presented in this document does not form part of any quotation or contract, is believed to be accurate and reliable and may be changed without notice.