

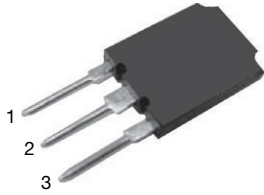

## Thyristor High Voltage, Phase Control SCR, 70 A

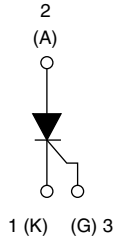

Super TO-247



### FEATURES

- High surge capability
- High voltage input rectification
- Designed and qualified according to JEDEC®-JESD47
- Material categorization: For definitions of compliance please see [www.vishay.com/doc?99912](http://www.vishay.com/doc?99912)



RoHS COMPLIANT

### APPLICATIONS

- AC switches
- High voltage input rectification (soft start)
- High current crow-bar
- Other phase-control circuits
- Designed to be used with Vishay input diodes, switches, and output rectifiers which are available in identical package outlines

### DESCRIPTION

The VS-70TPS..PbF high voltage series of silicon controlled rectifiers are specifically designed for high and medium power switching, and phase control applications.

PRODUCT SUMMARY	
Package	Super TO-247
Diode variation	Single SCR
$I_{T(AV)}$	70 A
$V_{DRM}/V_{RRM}$	1200 V, 1600 V
$V_{TM}$	1.25 V
$I_{GT}$	100 mA
$T_J$	-40 °C to 125 °C

MAJOR RATINGS AND CHARACTERISTICS			
PARAMETER	TEST CONDITIONS	VALUES	UNITS
$I_{T(AV)}$	Sinusoidal waveform	70	A
$I_{RMS}$	Lead current limitation	75	
$V_{RRM}/V_{DRM}$	Range	1200/1600	V
$I_{TSM}$		1100	A
$V_T$	100 A, $T_J = 25\text{ °C}$	1.4	V
dV/dt		500	V/ $\mu$ s
dI/dt		150	A/ $\mu$ s
$T_J$		-40 to 125	°C

VOLTAGE RATINGS			
PART NUMBER	$V_{RRM}/V_{DRM}$ , MAXIMUM REPETITIVE PEAK AND OFF-STATE VOLTAGE V	$V_{RSM}$ , MAXIMUM NON-REPETITIVE PEAK REVERSE VOLTAGE V	$I_{RRM}/I_{DRM}$ AT 125 °C mA
VS-70TPS12PbF	1200	1300	15
VS-70TPS16PbF	1600	1700	



ABSOLUTE MAXIMUM RATINGS					
PARAMETER	SYMBOL	TEST CONDITIONS		VALUES	UNITS
Maximum average on-state current	$I_{T(AV)}$	$T_C = 82\text{ }^\circ\text{C}$ , 180° conduction half sine wave		70	A
Maximum continuous RMS on-state current as AC switch	$I_{T(RMS)}$	Lead current limitation		75	
Maximum peak, one-cycle non-repetitive surge current	$I_{TSM}$	10 ms sine pulse, rated $V_{RRM}$ applied		930	
		10 ms sine pulse, no voltage reapplied		1100	
Maximum $I^2t$ for fusing	$I^2t$	10 ms sine pulse, rated $V_{RRM}$ applied		4325	A <sup>2</sup> s
		10 ms sine pulse, no voltage reapplied		6115	
Maximum $I^2\sqrt{t}$ for fusing	$I^2\sqrt{t}$	$t = 0.1\text{ ms to }10\text{ ms}$ , no voltage reapplied		61 150	A <sup>2</sup> √s
Low level value of threshold voltage	$V_{T(TO)1}$	$T_J = 125\text{ }^\circ\text{C}$		0.916	V
High level value of threshold voltage	$V_{T(TO)2}$			1.21	
Low level value of on-state slope resistance	$r_{t1}$			4.138	mΩ
High level value of on-state slope resistance	$r_{t2}$			3.43	
Maximum peak on-state voltage	$V_{TM}$	100 A, $T_J = 25\text{ }^\circ\text{C}$		1.4	V
Maximum rate of rise of turned-on current	$di/dt$	$T_J = 25\text{ }^\circ\text{C}$		150	A/μs
Maximum holding current	$I_H$	Anode supply = 6 V, resistive load, initial $I_T = 1\text{ A}$ , $T_J = 25\text{ }^\circ\text{C}$		200	mA
Maximum latching current	$I_L$	Anode supply = 6 V, resistive load, $T_J = 25\text{ }^\circ\text{C}$		400	
Maximum reverse and direct leakage current	$I_{RRM}/I_{DRM}$	$T_J = 25\text{ }^\circ\text{C}$	$V_R = \text{Rated } V_{RRM}/V_{DRM}$ ( $T_J = T_J \text{ max.}$ , linear to 80 % $V_{DRM} = R_g\text{-k} = \text{Open}$ )	1.0	
		$T_J = 125\text{ }^\circ\text{C}$		15	
Maximum rate of rise of off-state voltage	$dV/dt$	$T_J = 125\text{ }^\circ\text{C}$		500	V/μs

TRIGGERING					
PARAMETER	SYMBOL	TEST CONDITIONS		VALUES	UNITS
Maximum peak gate power	$P_{GM}$	$T = 30\text{ }\mu\text{s}$		10	W
Maximum average gate power	$P_{G(AV)}$			2.5	
Maximum peak gate current	$I_{GM}$			2.5	A
Maximum peak negative gate voltage	$-V_{GM}$			10	V
Maximum required DC gate voltage to trigger	$V_{GT}$	$T_J = -40\text{ }^\circ\text{C}$	Anode supply = 6 V resistive load	1.8	
		$T_J = 25\text{ }^\circ\text{C}$		1.5	
		$T_J = 125\text{ }^\circ\text{C}$		1.1	
Maximum required DC gate current to trigger	$I_{GT}$	$T_J = -40\text{ }^\circ\text{C}$	Anode supply = 6 V resistive load	150	mA
		$T_J = 25\text{ }^\circ\text{C}$		100	
		$T_J = 125\text{ }^\circ\text{C}$		80	
Maximum DC gate voltage not to trigger	$V_{GD}$	$T_J = 125\text{ }^\circ\text{C}$ , $V_{DRM} = \text{Rated value}$		0.25	V
Maximum DC gate current not to trigger	$I_{GD}$			6	mA



THERMAL AND MECHANICAL SPECIFICATIONS				
PARAMETER	SYMBOL	TEST CONDITIONS	VALUES	UNITS
Maximum junction temperature range	$T_J$		-40 to 125	°C
Maximum storage temperature range	$T_{Stg}$		-40 to 150	
Maximum thermal resistance, junction to case	$R_{thJC}$	DC operation	0.27	°C/W
Maximum thermal resistance, junction to ambient	$R_{thJA}$		40	
Typical thermal resistance, case to heatsink	$R_{thCS}$	Mounting surface, smooth and greased	0.2	
Approximate weight			6	g
			0.21	oz.
Mounting torque	minimum		6 (5)	kgf · cm (lbf · in)
	maximum		12 (10)	
Marking device		Case style Super TO-247	70TPS12	
			70TPS16	

$\Delta R_{thJ-hs}$ CONDUCTION PER JUNCTION											
DEVICE	SINE HALF WAVE CONDUCTION					RECTANGULAR WAVE CONDUCTION					UNITS
	180°	120°	90°	60°	30°	180°	120°	90°	60°	30°	
VS-70TPS..PbF	0.078	0.092	0.117	0.172	0.302	0.053	0.092	0.125	0.180	0.306	°C/W

**Note**

- The table above shows the increment of thermal resistance  $R_{thJ-hs}$  when devices operate at different conduction angles than DC

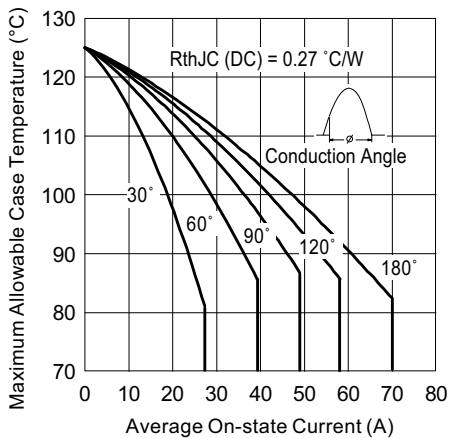

Fig. 1 - Current Rating Characteristics

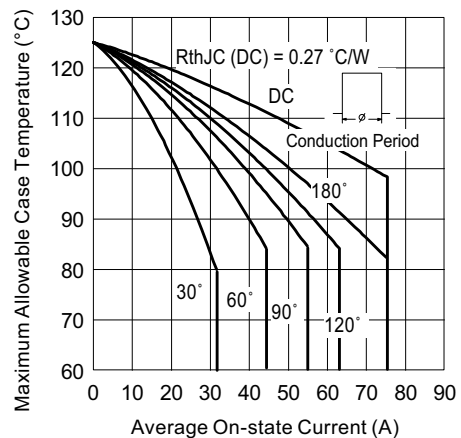

Fig. 2 - Current Rating Characteristics

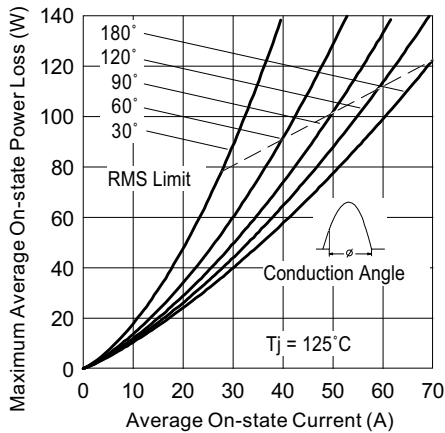

Fig. 3 - On-State Power Loss Characteristics

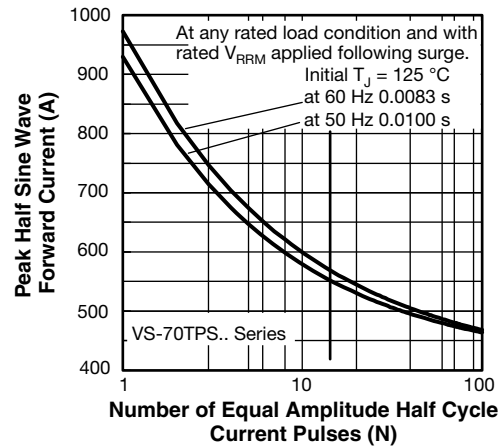

Fig. 5 - Maximum Non-Repetitive Surge Current

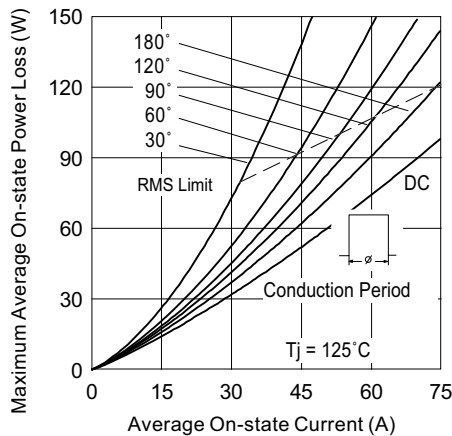

Fig. 4 - On-State Power Loss Characteristics

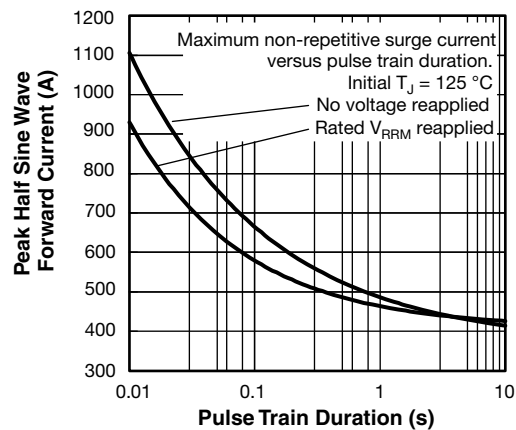

Fig. 6 - Maximum Non-Repetitive Surge Current

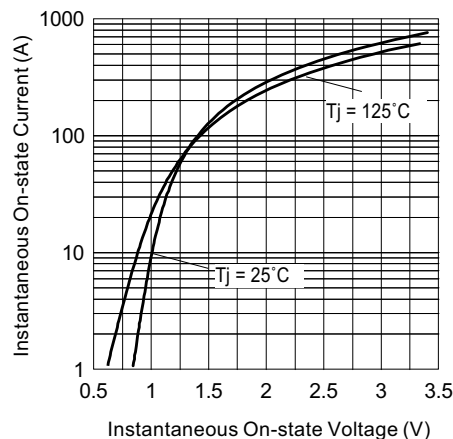

Fig. 7 - On-State Voltage Drop Characteristics

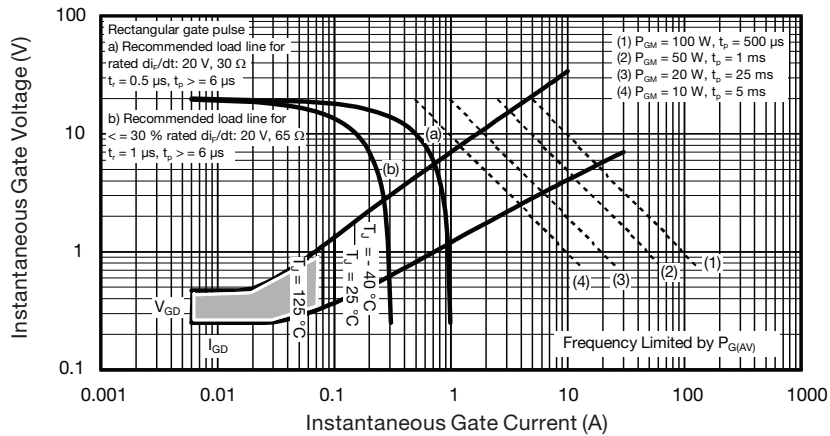

Fig. 8 - Gate Characteristics

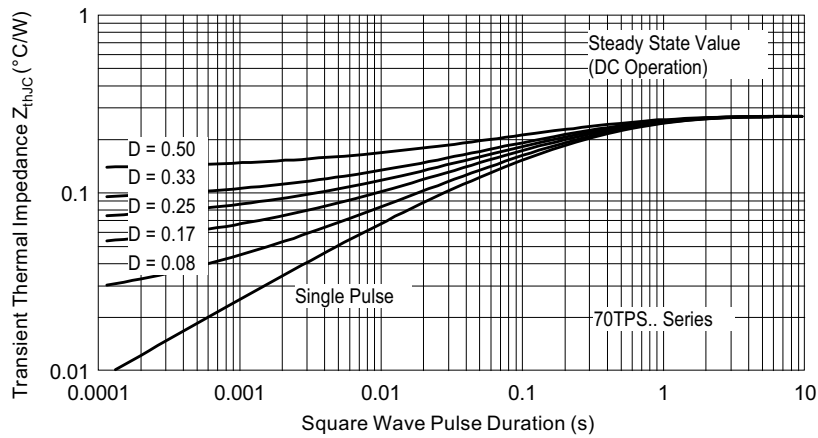
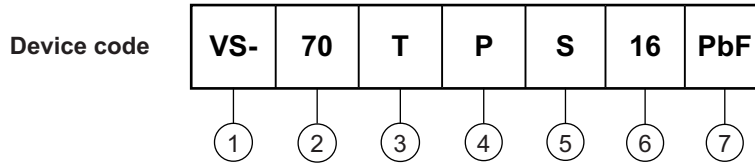

Fig. 9 - Thermal Impedance  $Z_{thJC}$  Characteristics



## ORDERING INFORMATION TABLE



- 1** - Vishay Semiconductors product
- 2** - Current rating (70 = 70 A)
- 3** - Circuit configuration:  
T = Thyristor
- 4** - Package:  
P = Super TO-247
- 5** - Type of silicon:  
S = Standard recovery rectifier
- 6** - Voltage code x 100 =  $V_{RRM}$ 

12 = 1200 V
16 = 1600 V
- 7** - PbF = Lead (Pb)-free

ORDERING INFORMATION (example)			
PREFERRED P/N	QUANTITY PER T/R	MINIMUM ORDER QUANTITY	PACKAGING DESCRIPTION
VS-70TPS12PbF	25	500	Antistatic plastic tube
VS-70TPS16PbF	25	500	Antistatic plastic tube

LINKS TO RELATED DOCUMENTS	
Dimensions	<a href="http://www.vishay.com/doc?95073">www.vishay.com/doc?95073</a>
Part marking information	<a href="http://www.vishay.com/doc?95070">www.vishay.com/doc?95070</a>

## Super TO-247

**DIMENSIONS** in millimeters (inches)

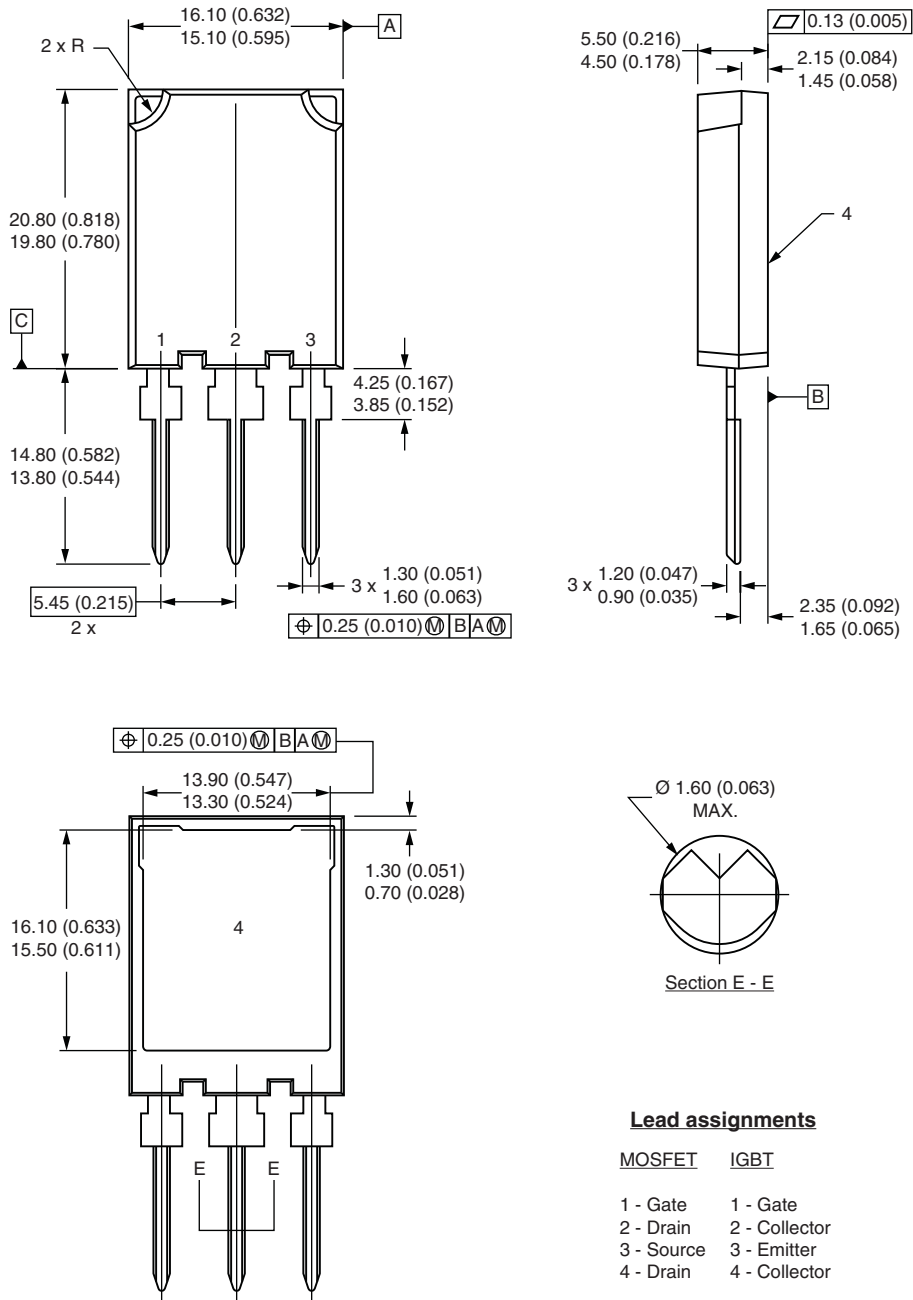

### Lead assignments

MOSFET	IGBT
1 - Gate	1 - Gate
2 - Drain	2 - Collector
3 - Source	3 - Emitter
4 - Drain	4 - Collector

### Notes

- (1) Dimension and tolerancing per ASME Y14.5M-1994
- (2) Controlling dimension: millimeter
- (3) Outline conforms to JEDEC® outline TO-274AA



## **Disclaimer**

ALL PRODUCT, PRODUCT SPECIFICATIONS AND DATA ARE SUBJECT TO CHANGE WITHOUT NOTICE TO IMPROVE RELIABILITY, FUNCTION OR DESIGN OR OTHERWISE.

Vishay Intertechnology, Inc., its affiliates, agents, and employees, and all persons acting on its or their behalf (collectively, "Vishay"), disclaim any and all liability for any errors, inaccuracies or incompleteness contained in any datasheet or in any other disclosure relating to any product.

Vishay makes no warranty, representation or guarantee regarding the suitability of the products for any particular purpose or the continuing production of any product. To the maximum extent permitted by applicable law, Vishay disclaims (i) any and all liability arising out of the application or use of any product, (ii) any and all liability, including without limitation special, consequential or incidental damages, and (iii) any and all implied warranties, including warranties of fitness for particular purpose, non-infringement and merchantability.

Statements regarding the suitability of products for certain types of applications are based on Vishay's knowledge of typical requirements that are often placed on Vishay products in generic applications. Such statements are not binding statements about the suitability of products for a particular application. It is the customer's responsibility to validate that a particular product with the properties described in the product specification is suitable for use in a particular application. Parameters provided in datasheets and / or specifications may vary in different applications and performance may vary over time. All operating parameters, including typical parameters, must be validated for each customer application by the customer's technical experts. Product specifications do not expand or otherwise modify Vishay's terms and conditions of purchase, including but not limited to the warranty expressed therein.

Except as expressly indicated in writing, Vishay products are not designed for use in medical, life-saving, or life-sustaining applications or for any other application in which the failure of the Vishay product could result in personal injury or death. Customers using or selling Vishay products not expressly indicated for use in such applications do so at their own risk. Please contact authorized Vishay personnel to obtain written terms and conditions regarding products designed for such applications.

No license, express or implied, by estoppel or otherwise, to any intellectual property rights is granted by this document or by any conduct of Vishay. Product names and markings noted herein may be trademarks of their respective owners.



# Mouser Electronics

Authorized Distributor

Click to View Pricing, Inventory, Delivery & Lifecycle Information:

[Vishay:](#)

[VS-70TPS12PBF](#) [VS-70TPS16PBF](#)